



DESIGN PROJECT

APARTMENT

STUDENT ALLA KHANIKYAN

YEREVAN 2024

Existing floor plan	3
Furniture Layout Drawings	4
Plumbing Layout Drawings	5
Heating Drawings	6
(1 & 3) Rooms Floor Covering Drafts	7
(1 & 3) Electrical Layout Drawings	8,9,10
(1 & 3) False ceiling plan	11,12,13
(1 & 3) Wall Layout Drawings	14,15, 16
(1 & 3) Furniture elevation drawings	17,18
Detailing	19
3D visualization	20-39

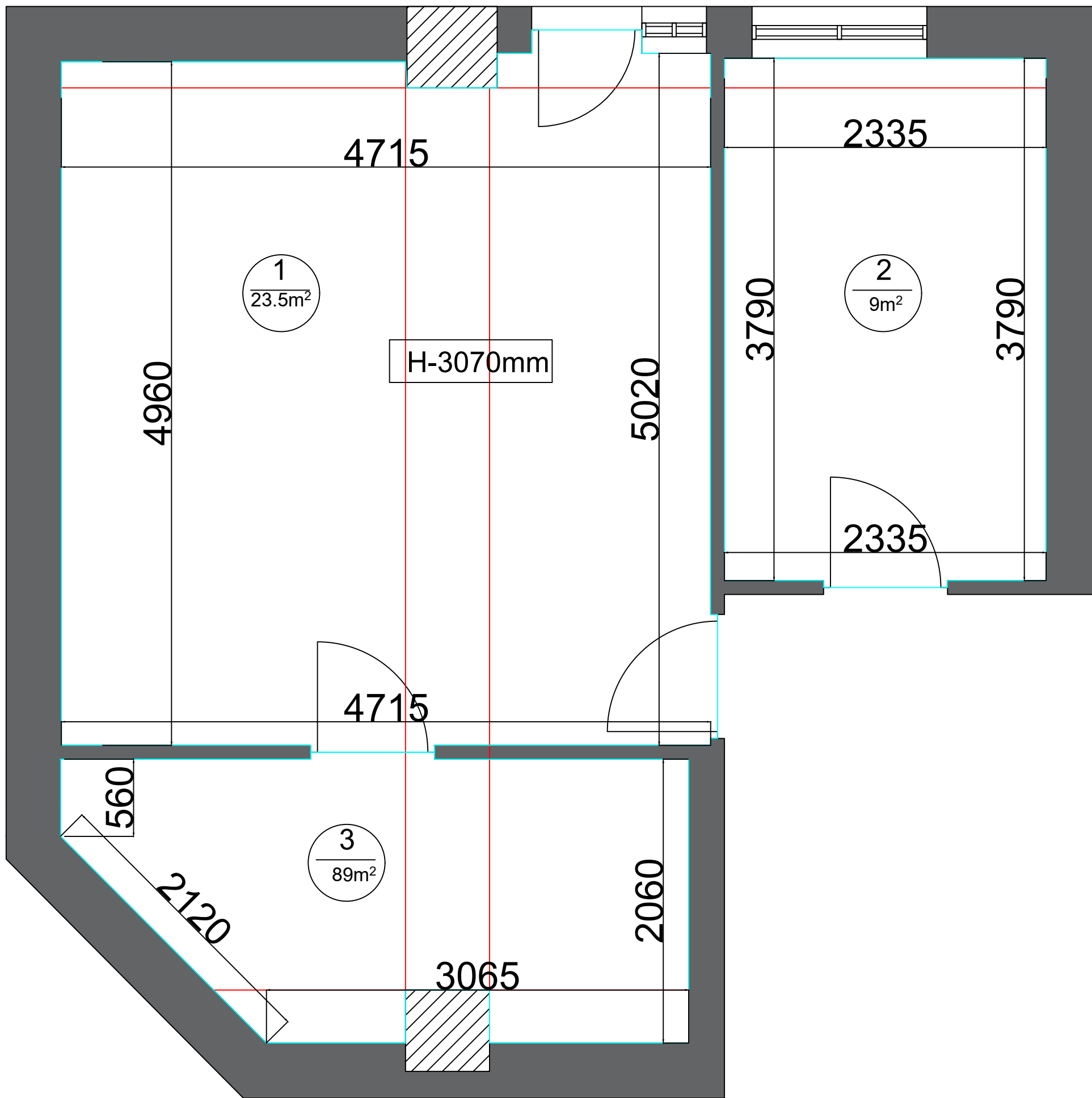

APARTMENT DESIGN PROJECT			Our address 16 Abovyan	
Founder	A. Danielyan	Existing floor plan	pages quantity	page number
Teacher	M. Yeghyan		39	3
Student	A. Khanikyan		"ARMAT Design School"	

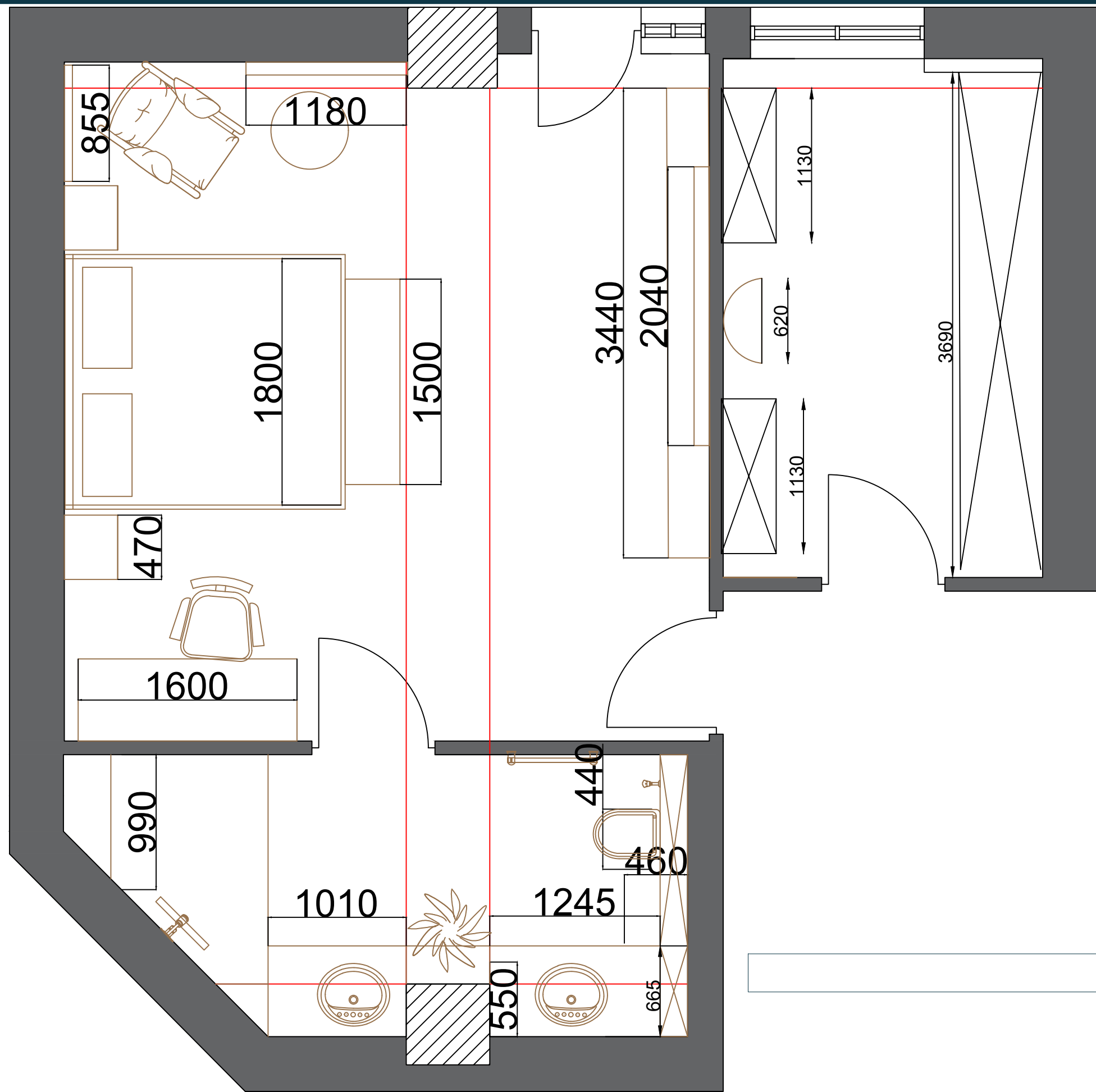

1. Bedroom	23.5 m ²
2. Closet	9m ²
3. Bathroom	8 m ²

Founder	A. Danielyan	
Teacher	M. Yeghyan	
Student	A. Khanikyan	

Existing floor plan

Our address 16 Abovyan	
pages quantity	page number
39	4
"ARMAT Design School"	

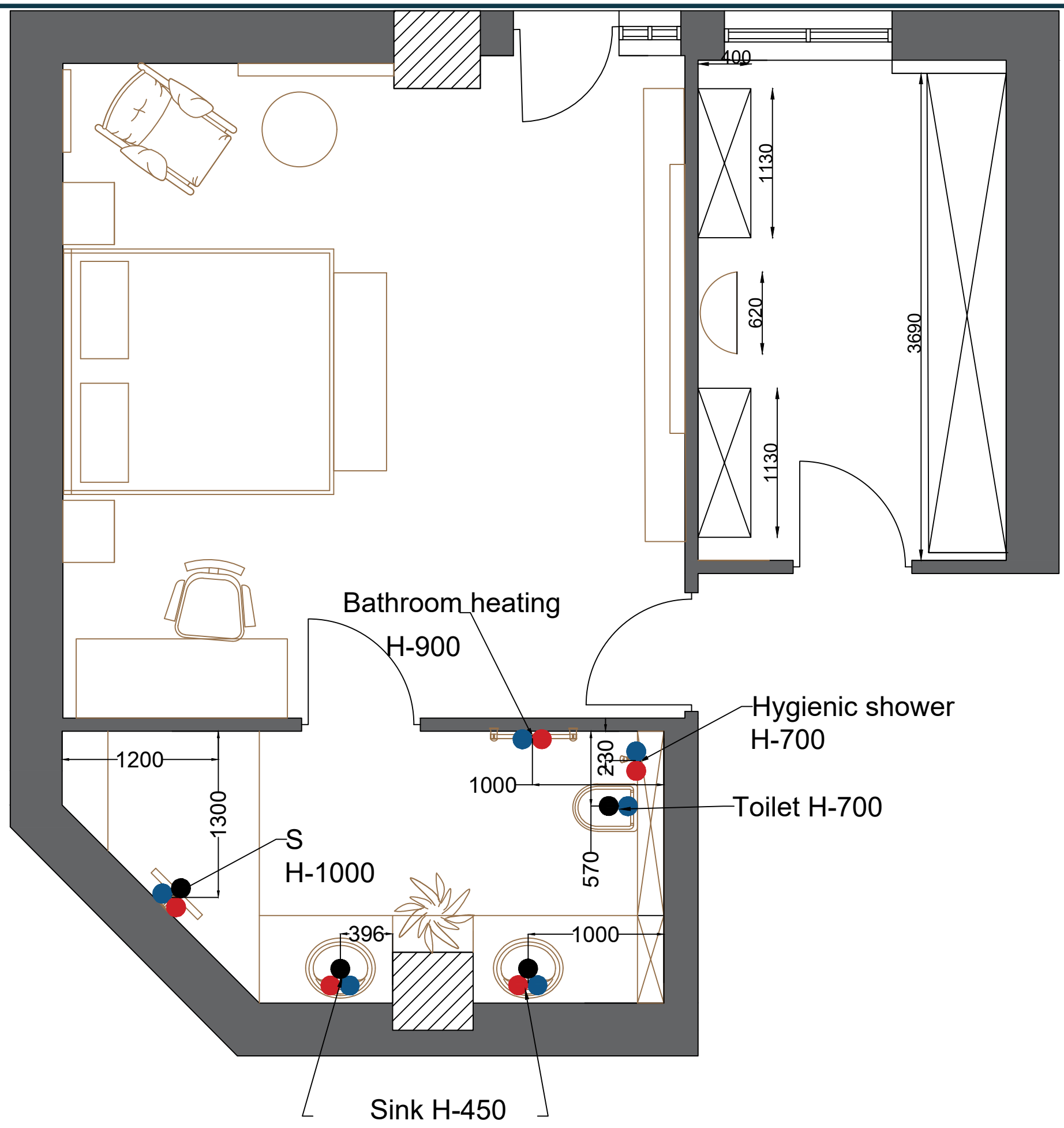

- Cold water
- Hot water
- Sewerage

APARTMENT DESIGN PROJECT			Our address 16 Abovyan	
Founder	A. Danielyan	Plumbing	pages quantity	page number
Teacher	M. Yeghyan			5
Student	A. Khanikyan			

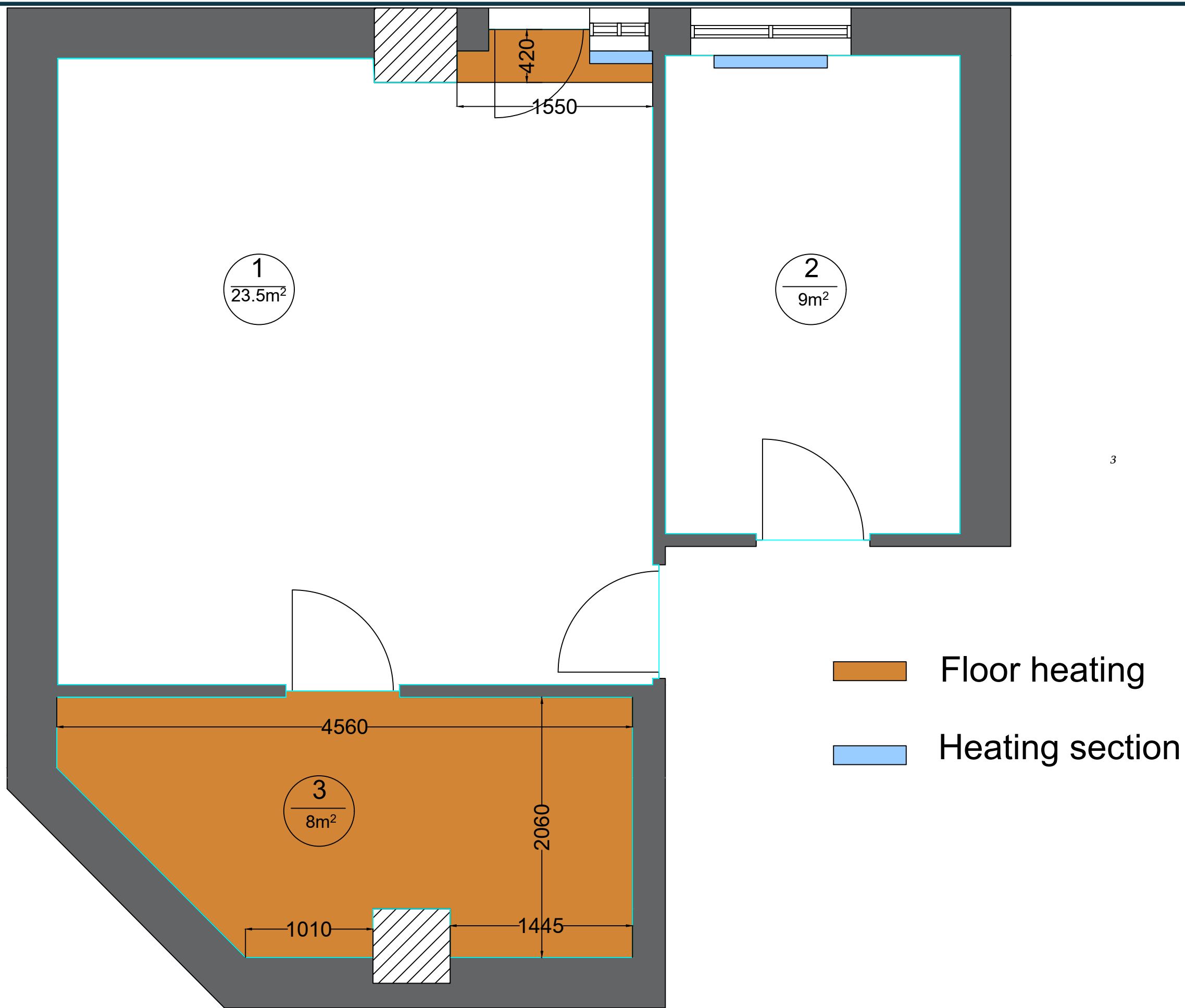

Apartment design project			Our address 16 Abovyan	
Founder	A.Danielyan	Heating Drawings	pages quantity	page number
Teacher	M.Yeghyan		39	6
Student	A.Khanikyan		ARMAT Design School	

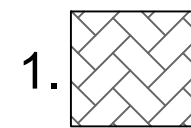
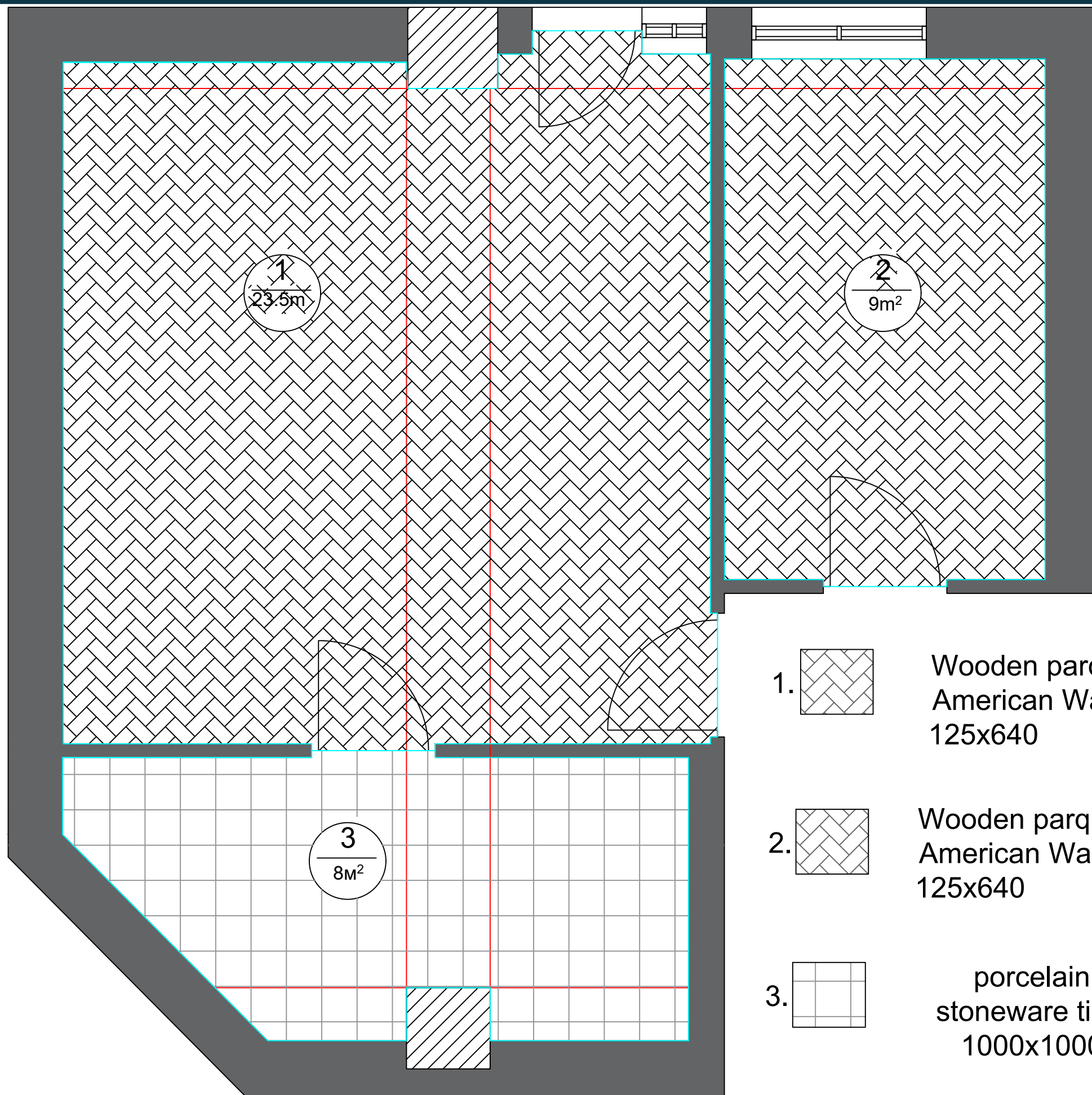

Wooden parquet
American Walnut
125x640

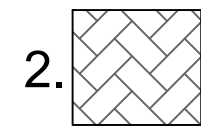

Wooden parquet
American Walnut
125x640

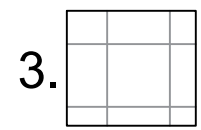

porcelain
stoneware tiles
1000x1000

Apartment design project			Our address 16 Abovyan	
Founder	A. Danielyan	Floor Covering Drafts	page quantity	page number
Teacher	M. Yeghyan		39	7
Student	A.Khanikyan		« ARMAT Design School»	

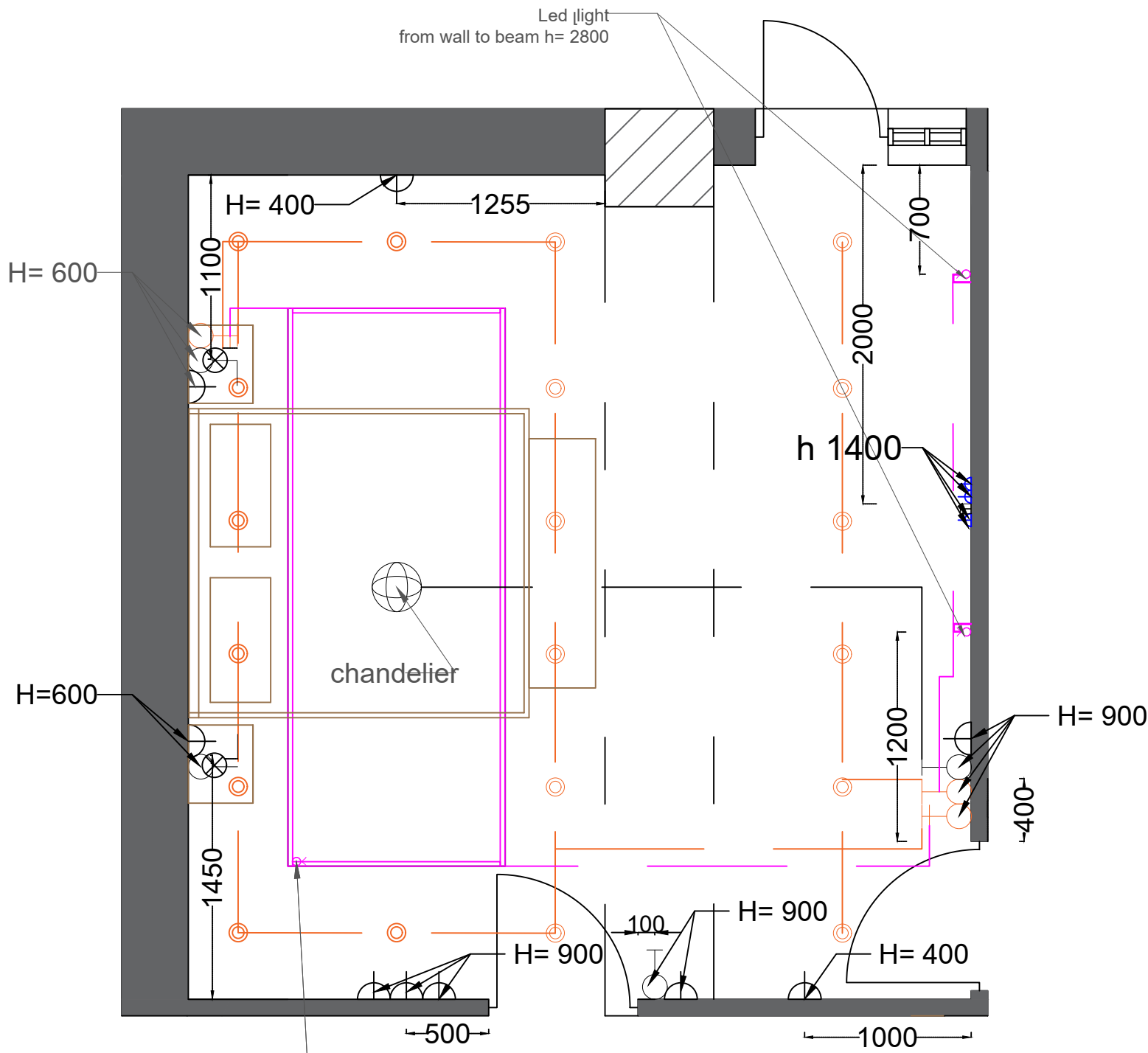

H= 600

H=600

Led light from wall to beam h= 2800

chandelier

h 1400

H= 900

Led light from ceiling

	Standard		Chandelier
	Reverse		Wire
	Reverse more than 2		Internet
	Plug		Heating panel
	grounding plug		Neon lighting
	Track Lighting		

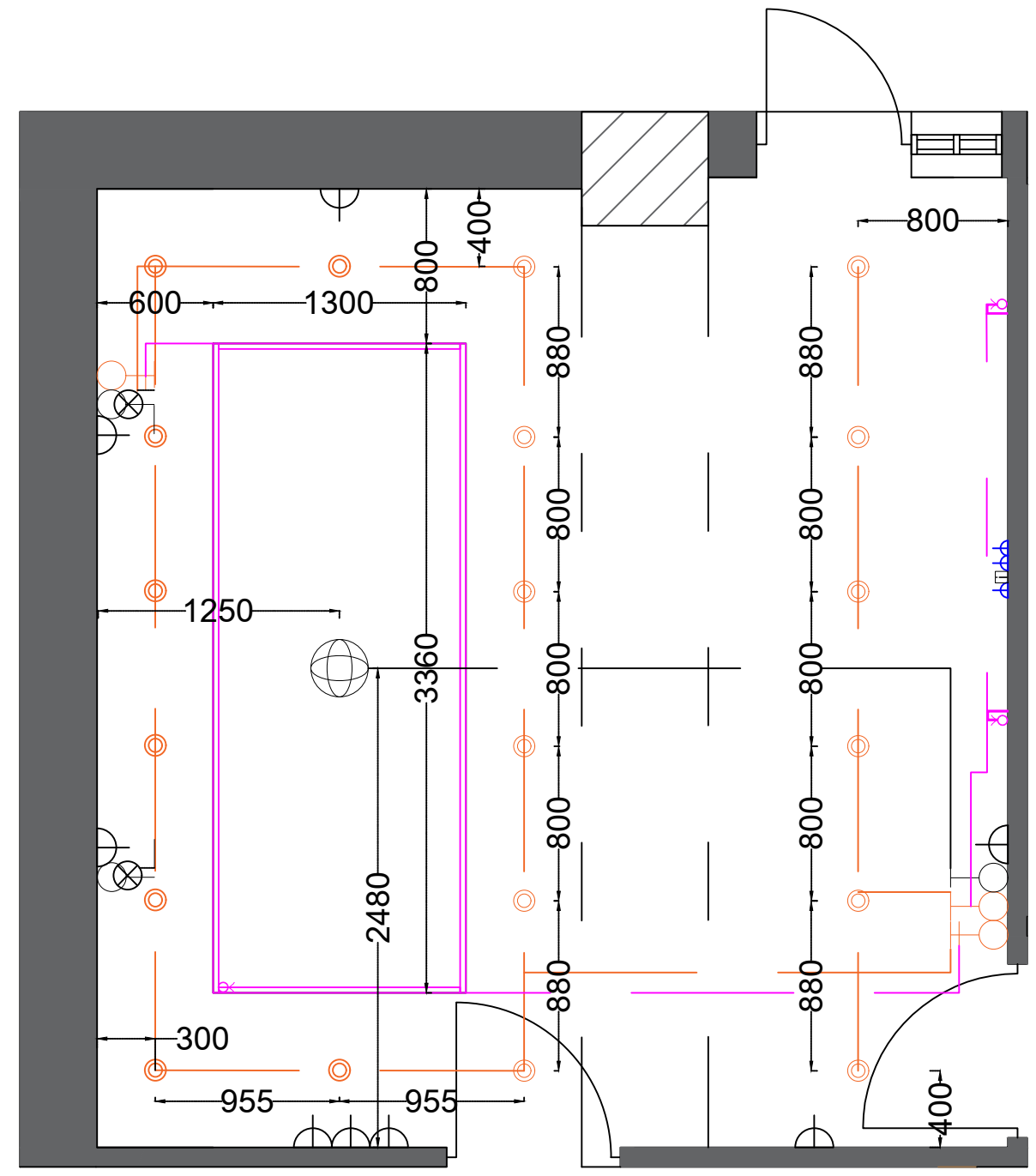

Apartment Design Project		Our address 16 Abovyan	
Founder	A. Danielyan	page quantity	page number
Teacher	M. Yeghyan	39	8
Student	A. Khanikyan	« ARMAT Design School »	

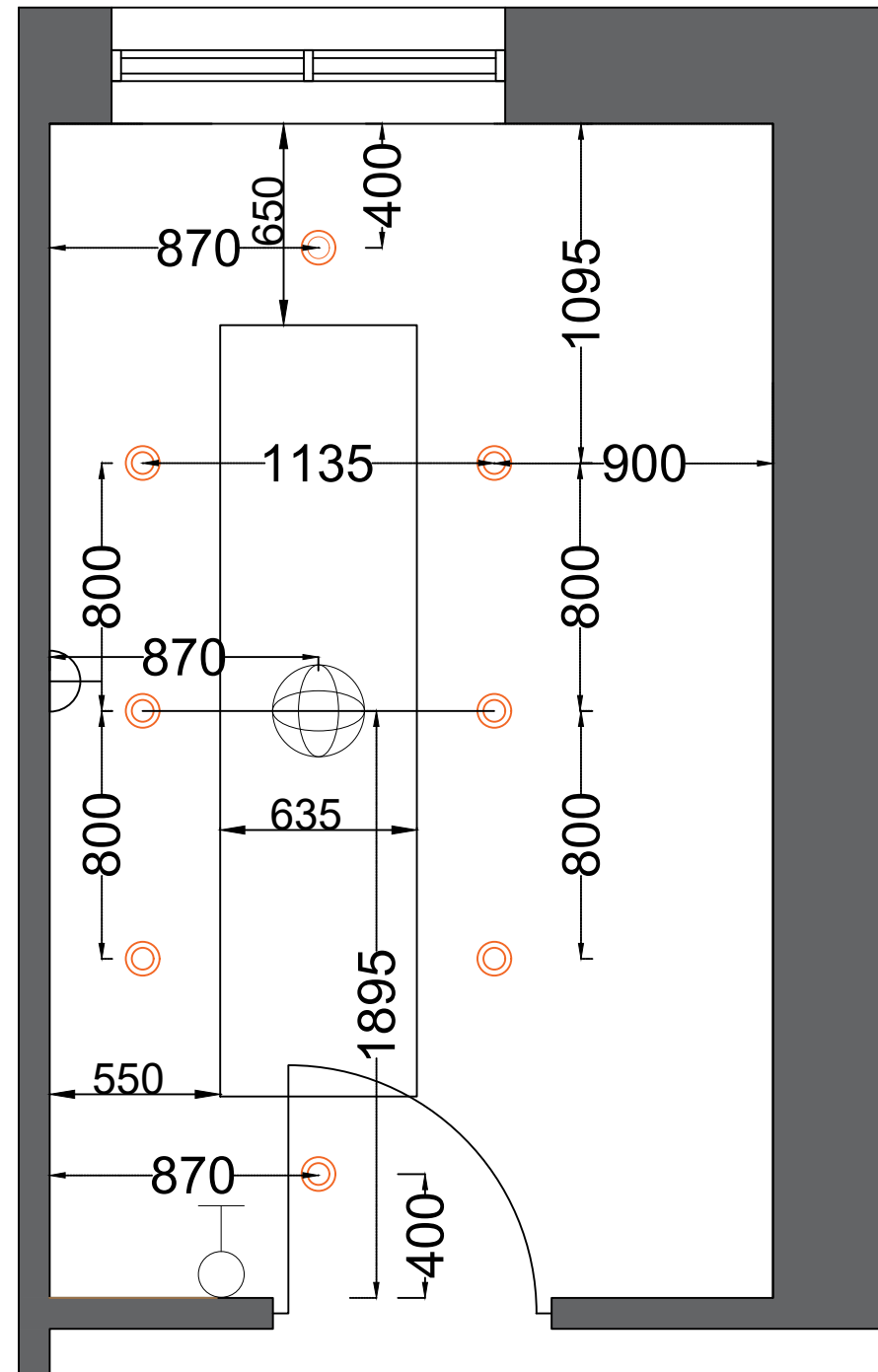
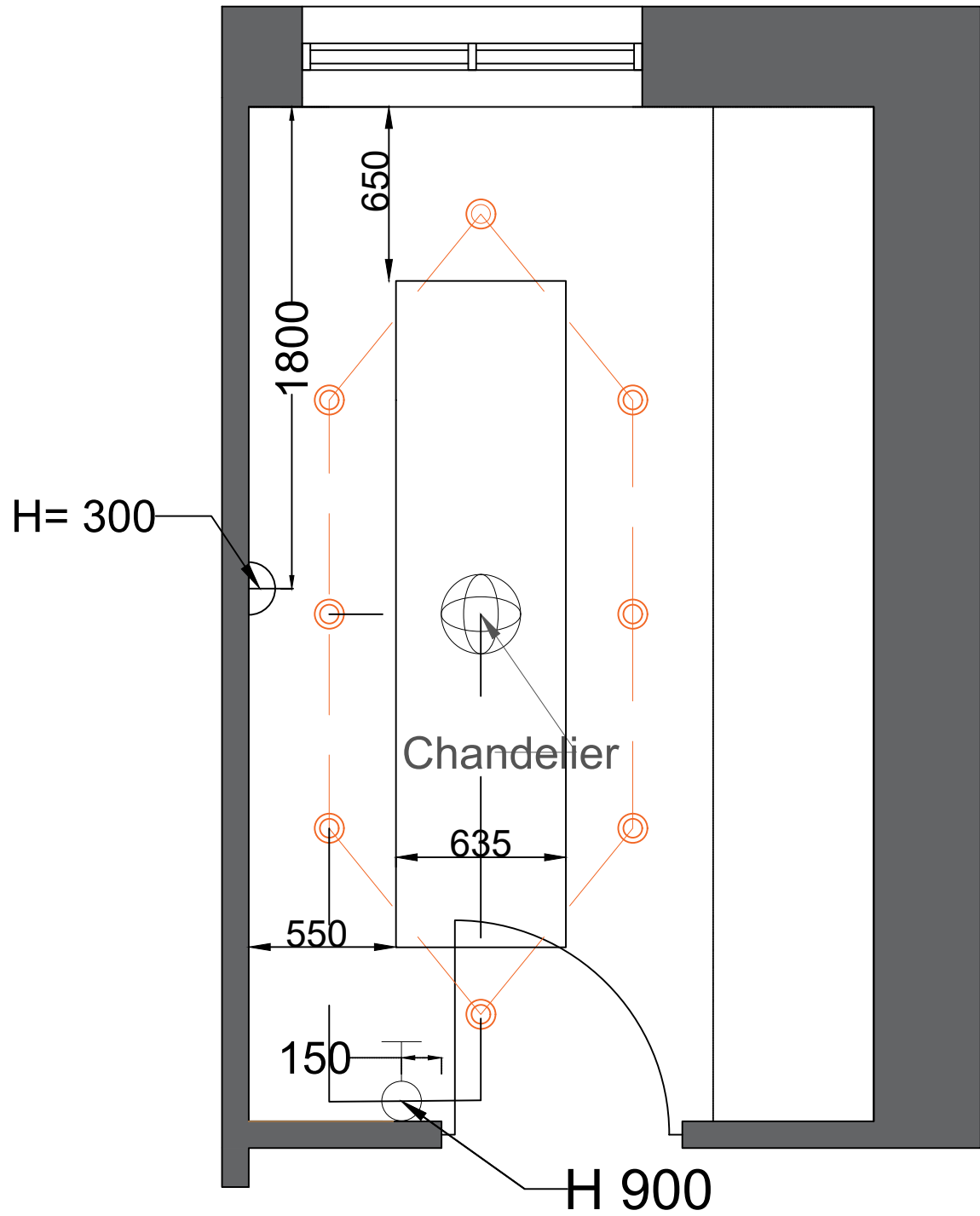

	Standard		Chandelier
	Reverse		Wire
	Reverse more than 2		Internet
	Plug		Heating panel
	grounding plug		Neon lighting
	Track Lighting		

Apartment Design Project		Our address 16 Abovyan	
Founder	A. Danielyan	page quantity	page number
Teacher	M. Yeghyan	39	9
Student	A. Khanikyan	« ARMAT Design School »	

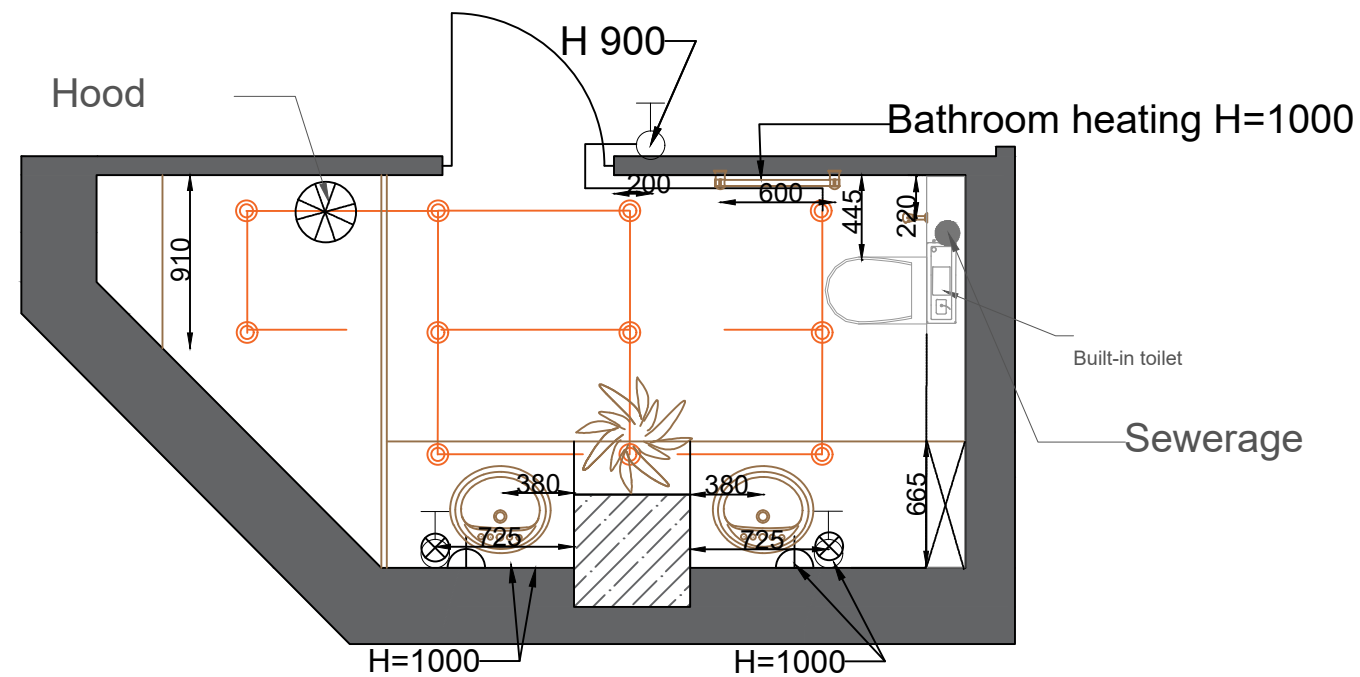
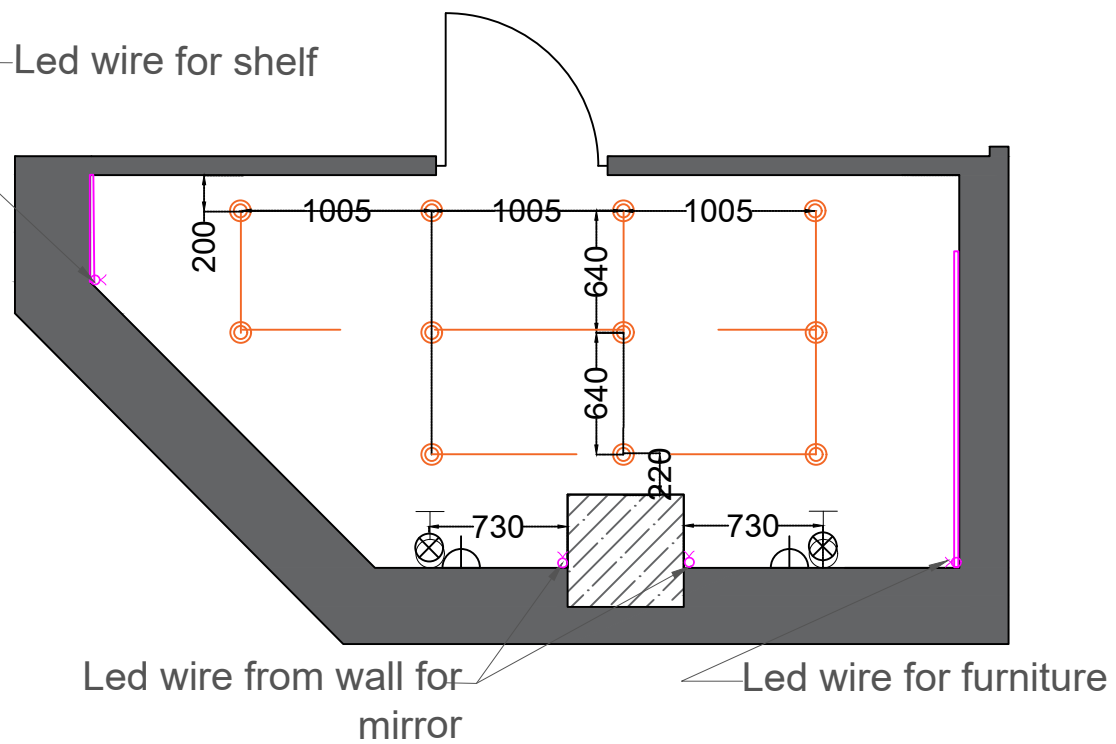

	Ստանդարտ		Ջահ
	Ուներս		Լադ
	Ուներս 2-ից ավել կետով		Ինտերնետ
	Վարդակ		Ձեռուցման վահանակ
	Յողանցումով վարդակ		Ներնային լույս
	Ուղեային լույս		

Apartment Design Project		Our address 16 Abovyan	
Founder	A. Danielyan	Electrical Layout Drawings	page quantity
Teacher	M. Yeghyan		page number
Student	A. Khanikyan		39
			« ARMAT Design School »



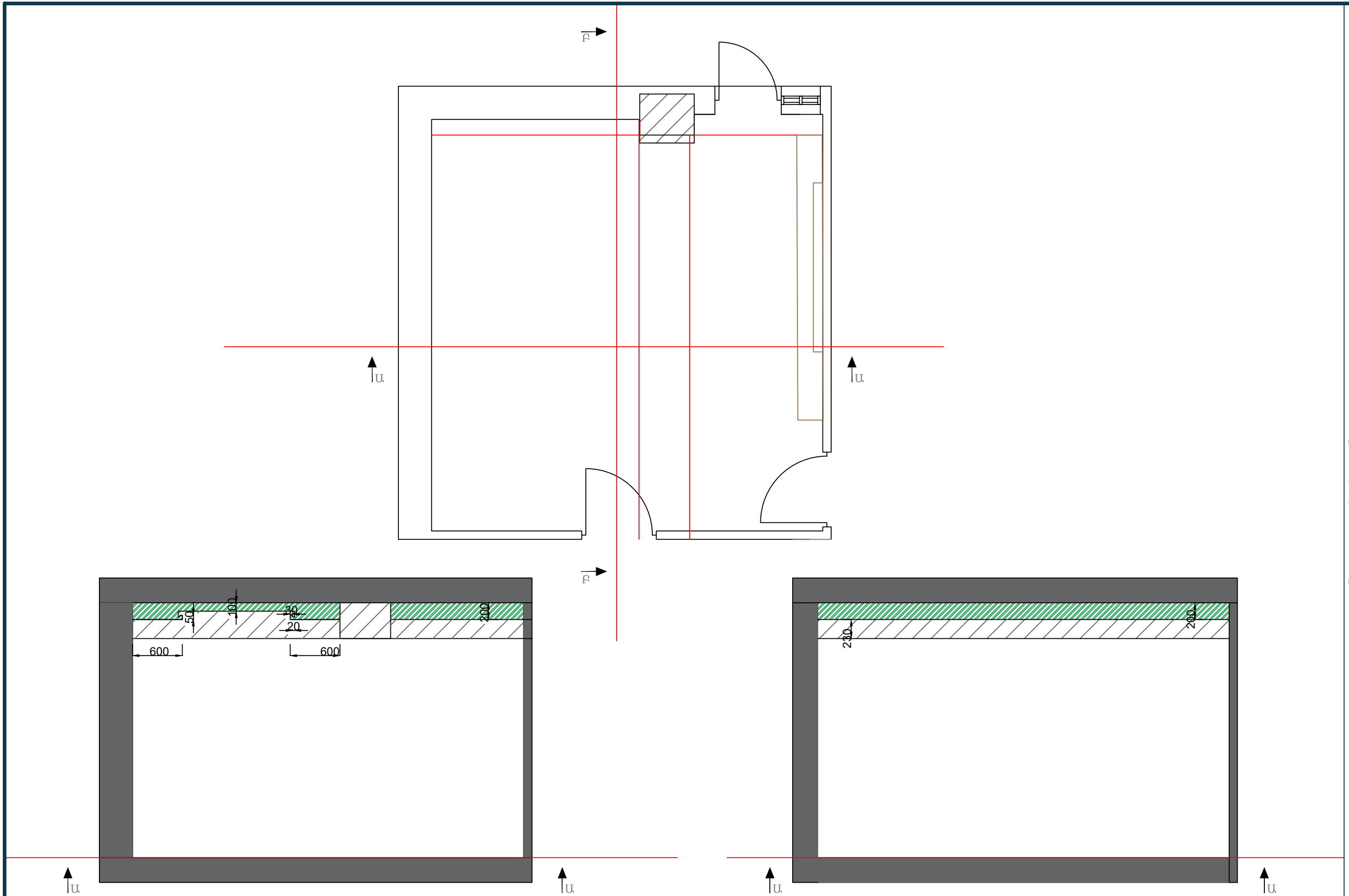

Apartment Design Project		Our address 16 Abovyan	
Founder	A. Danielyan	Electrical Layout Drawings	page quantity
Teacher	M. Yeghyan		page number
Student	A. Khanikyan		39
			« ARMAT Design School »

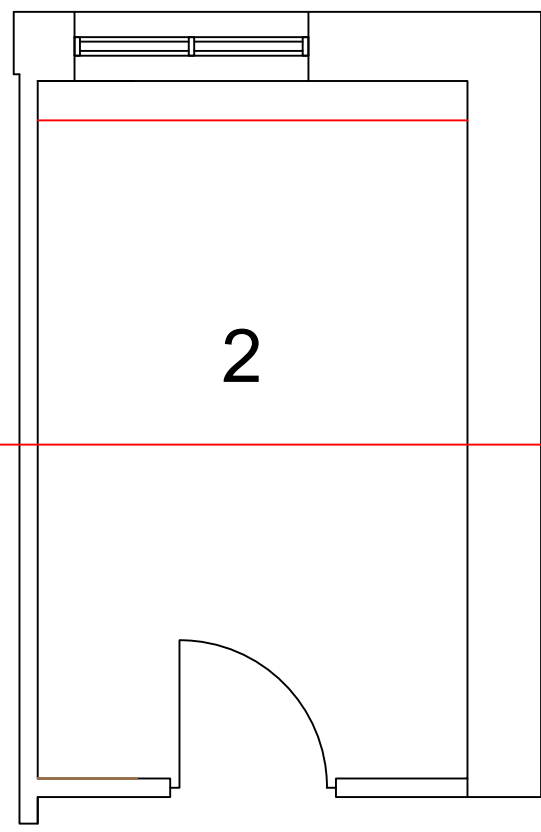

↑ A

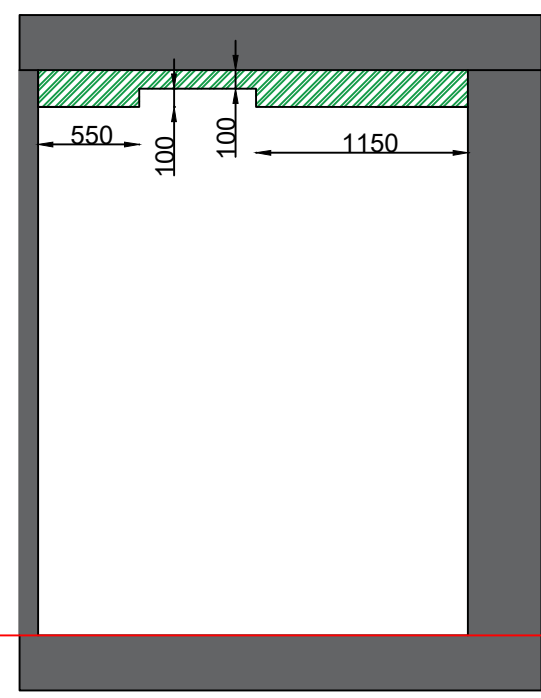

↑ A

↑ A

Apartment Design Project		Our address 16 Abovyan	
Founder	A. Danielyan	Electrical Layout Drawings	page quantity
Teacher	M. Yeghyan		page number
Student	A. Khanikyan		39
			« ARMAT Design School »

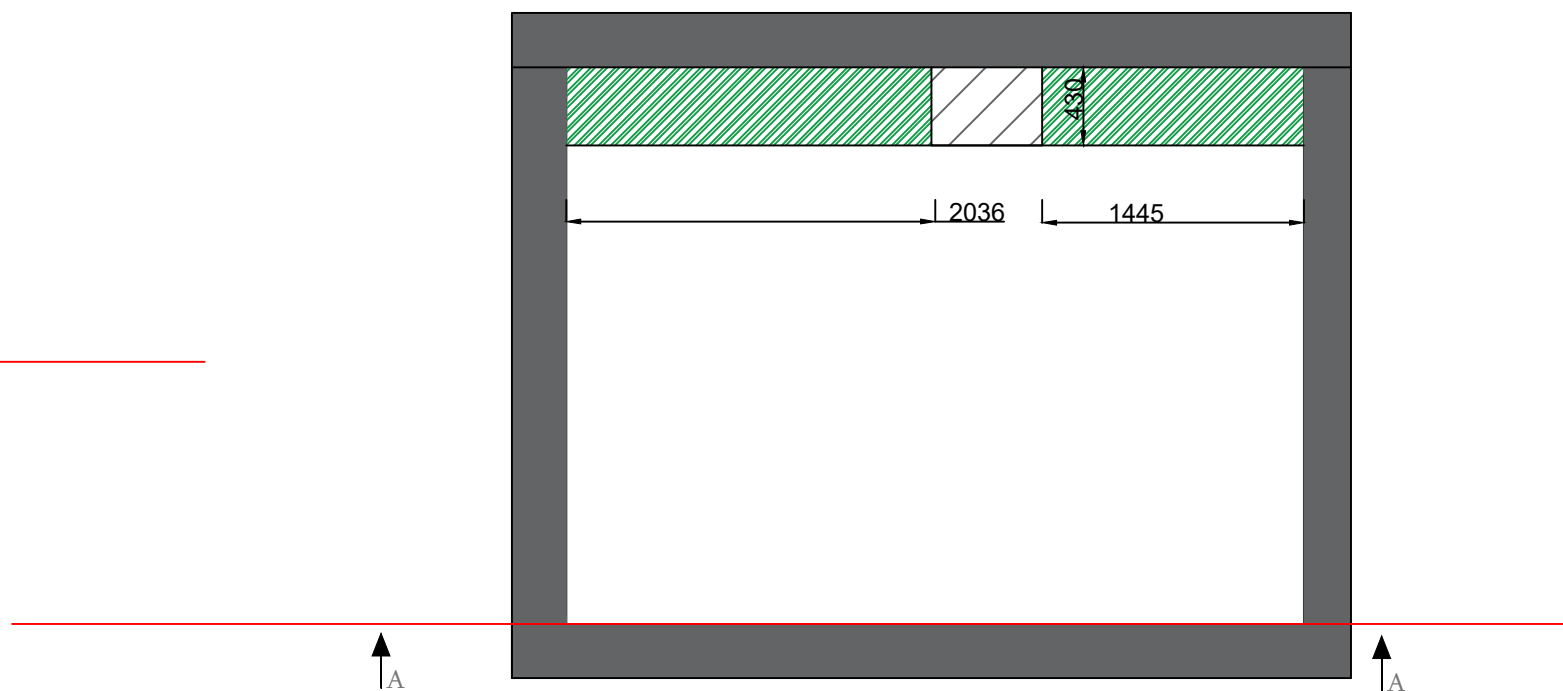
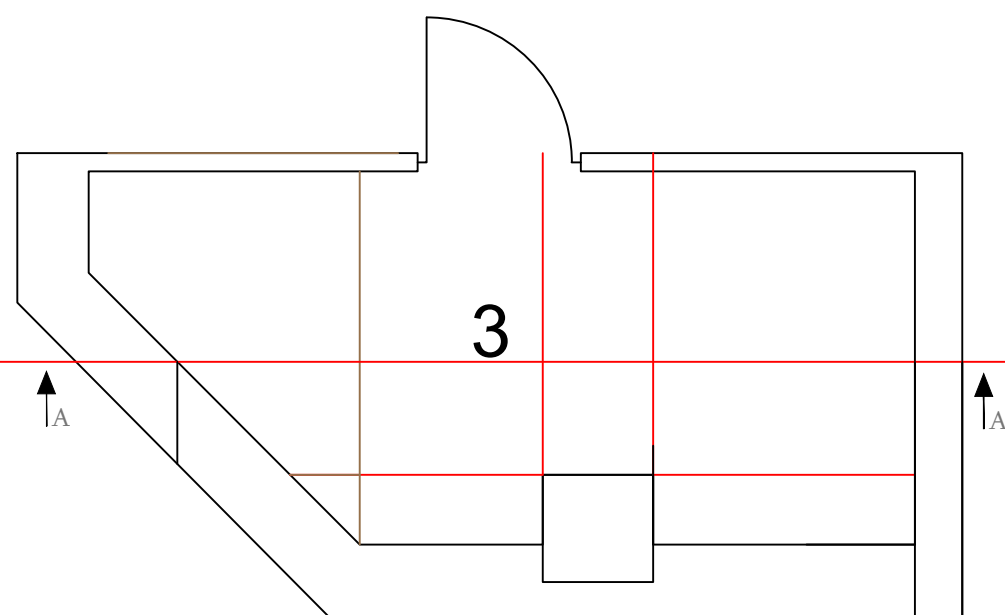

Apartment Design Project		Our address 16 Abovyan	
Founder	A. Danielyan	Electrical Layout Drawings	page quantity
Teacher	M. Yeghyan		page number
Student	A. Khanikyan		39
			« ARMAT Design School »

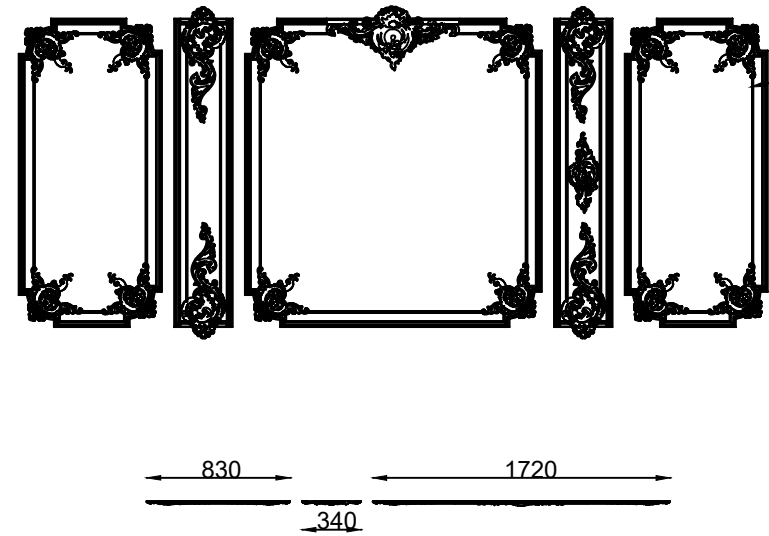
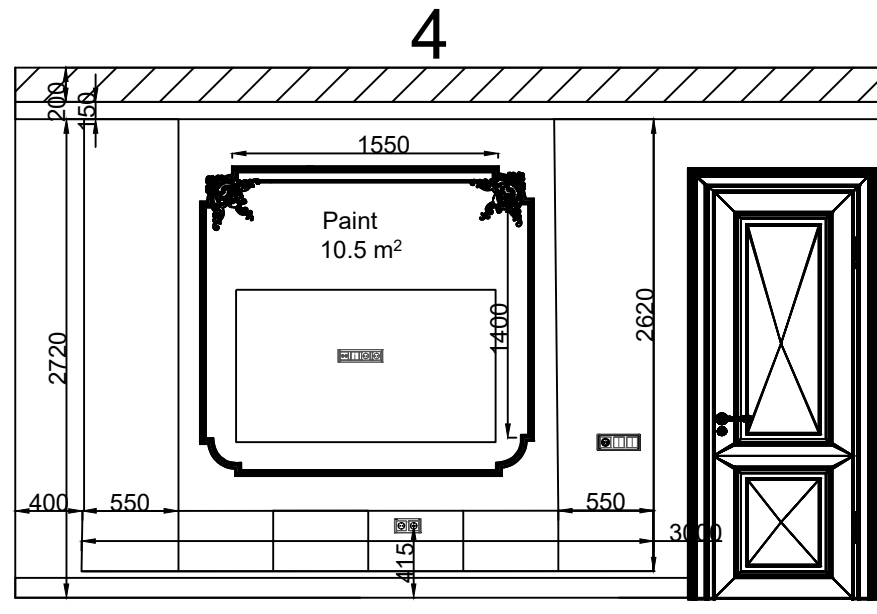
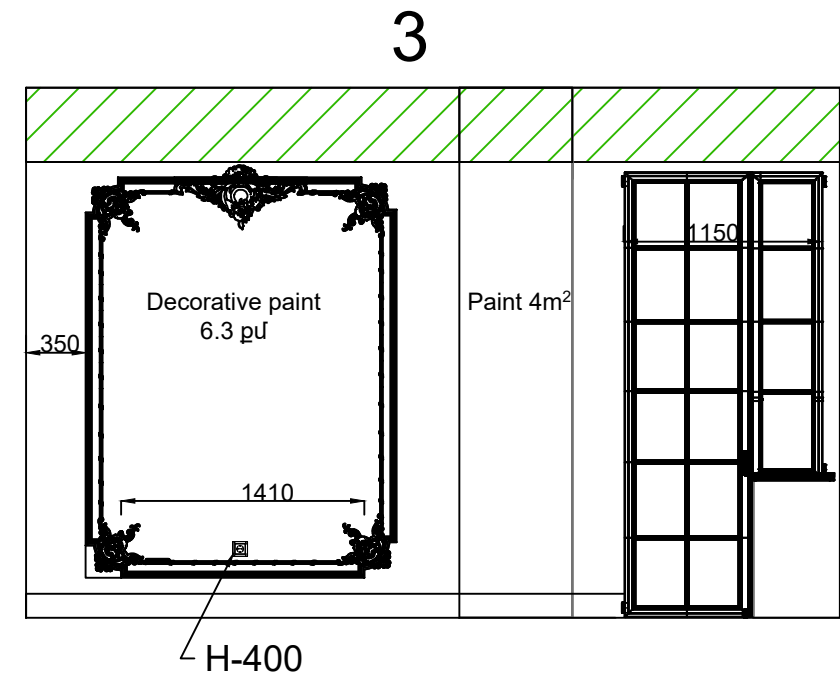
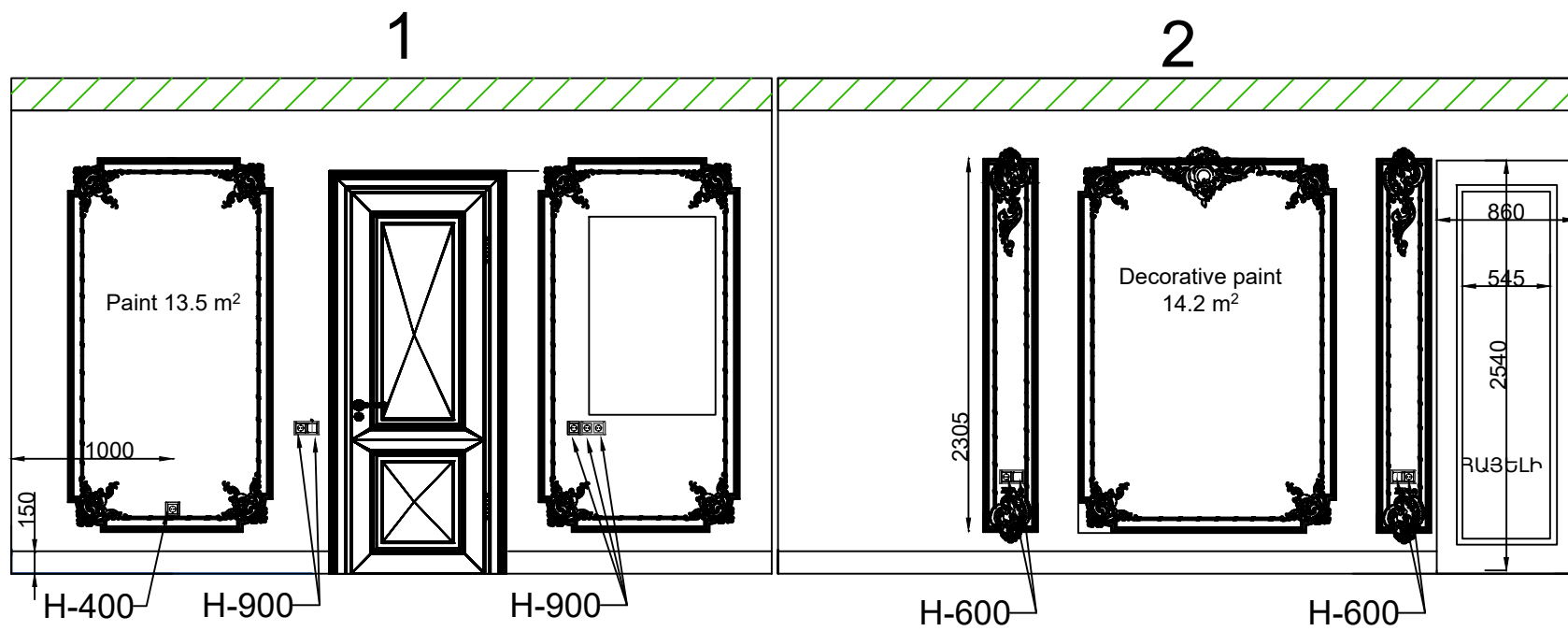

Frame-2

gypsum Г-16

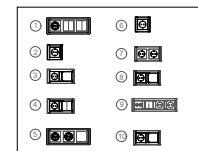
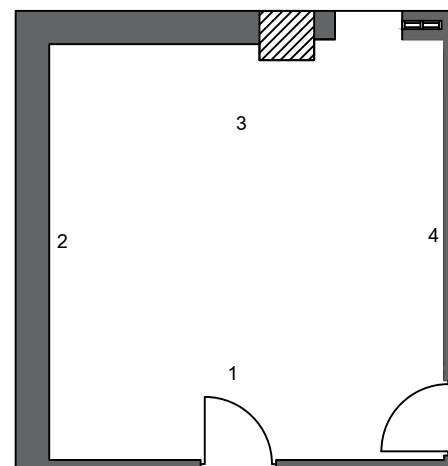
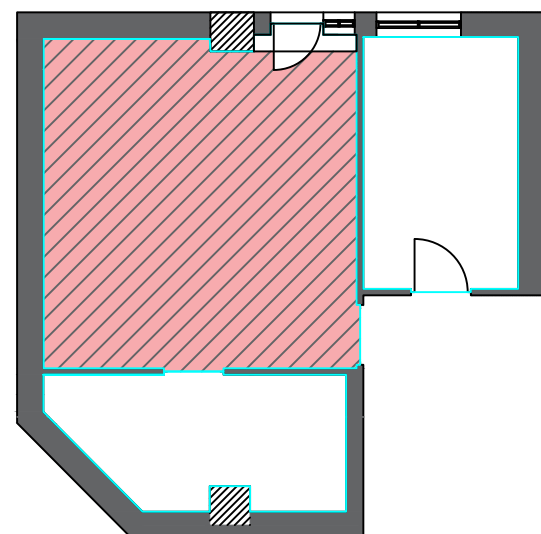
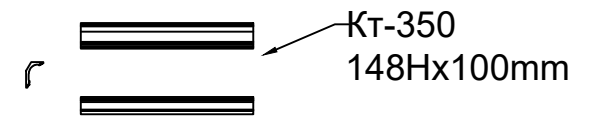
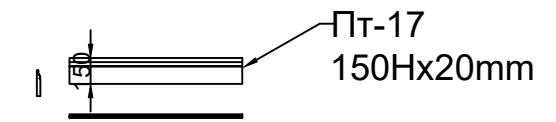

Apartment Design Project		Our address 16 Abovyan	
Founder	A. Danielyan	page quantity	page number
Teacher	M. Yeghyan	39	14
Student	A. Khanikyan	« ARMAT Design School »	

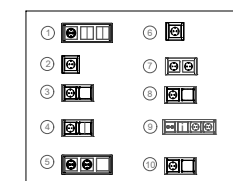
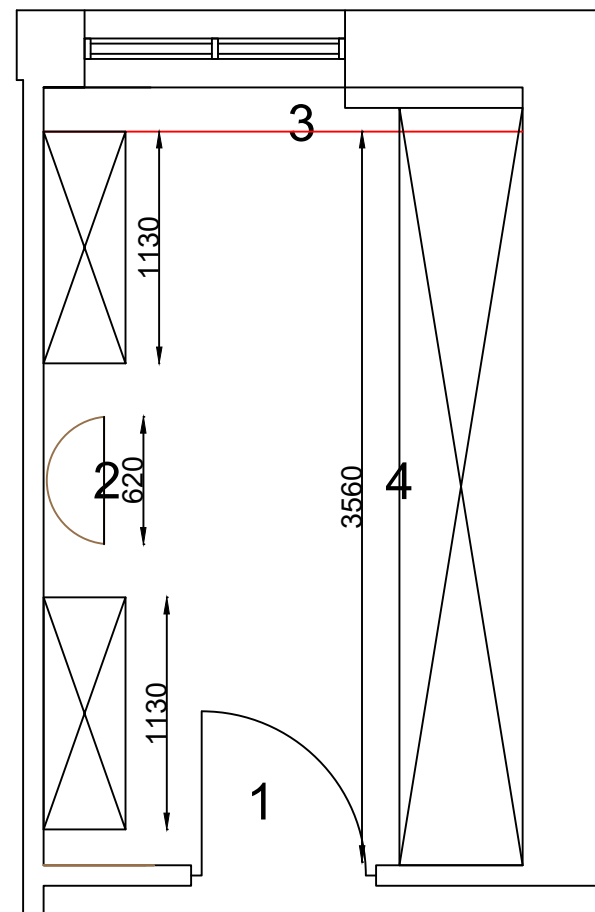
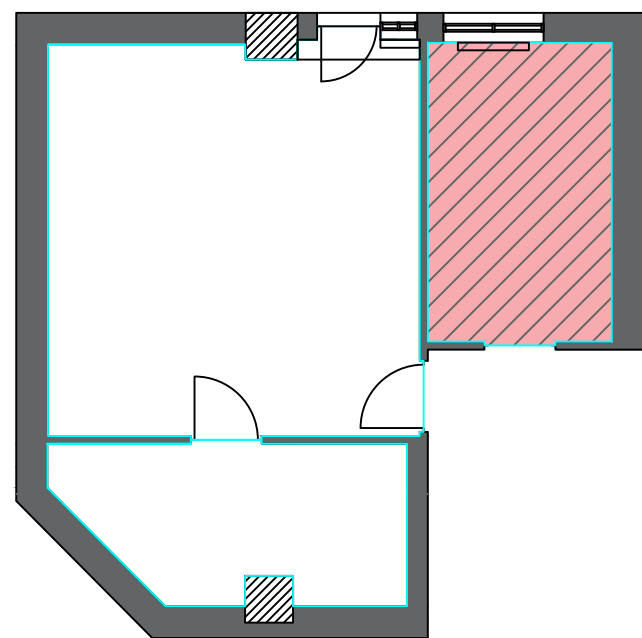
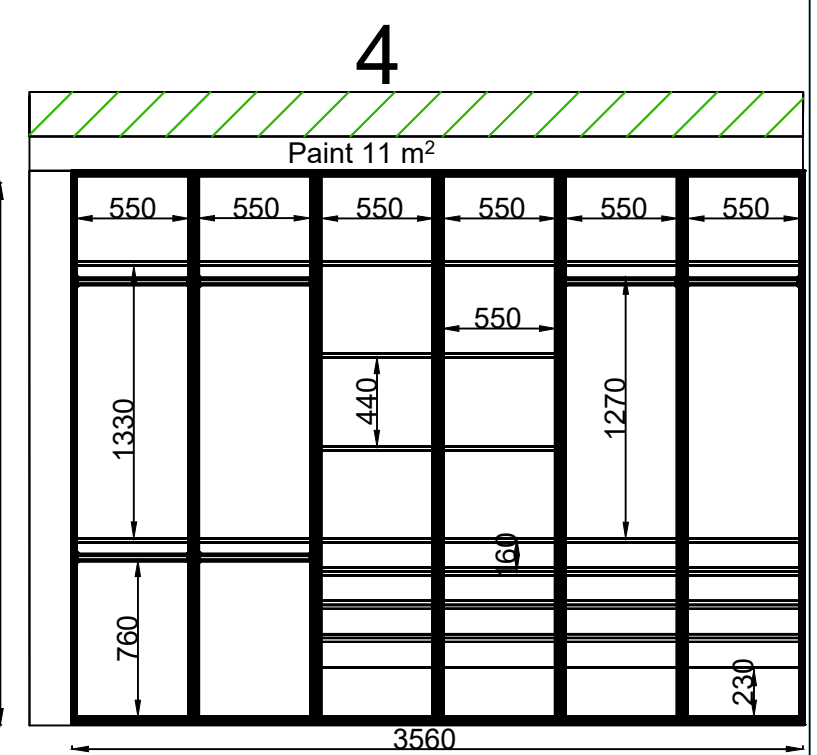
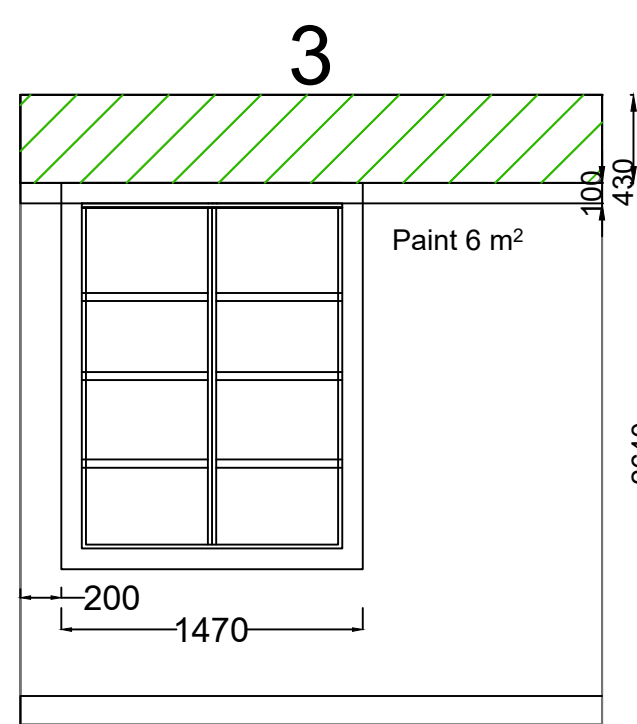
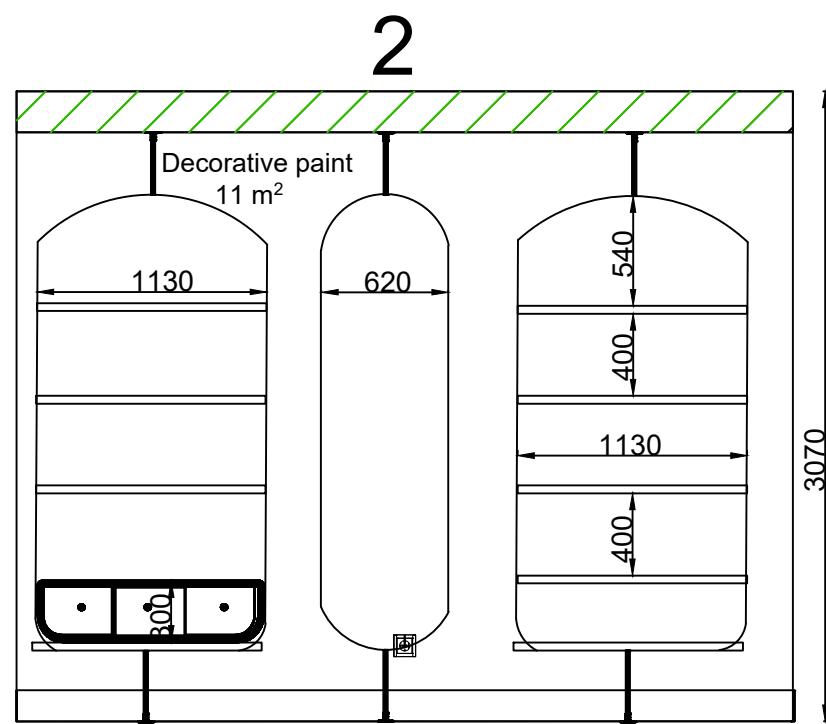
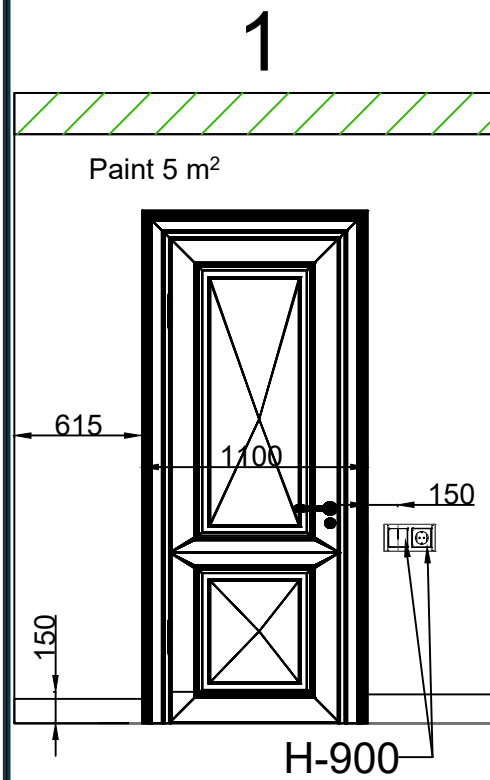

Apartment Design Project		Our address 16 Abovyan	
Founder	A. Danielyan	page quantity	page number
Teacher	M. Yeghyan	39	15
Student	A. Khanikyan	« ARMAT Design School »	

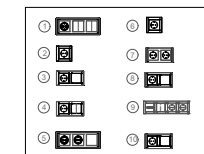
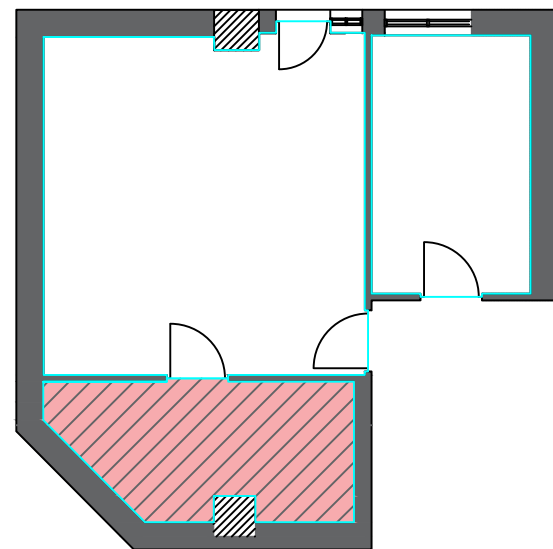
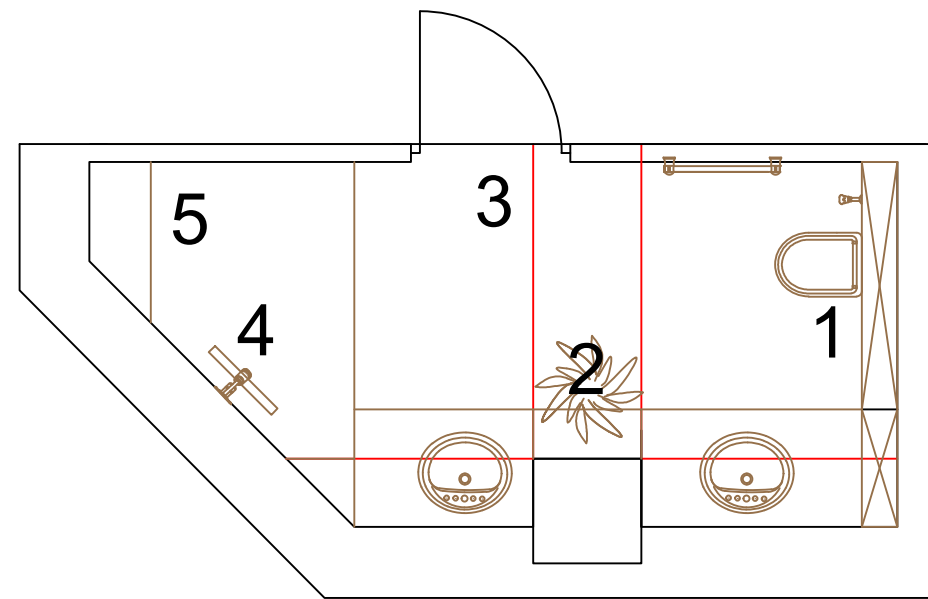
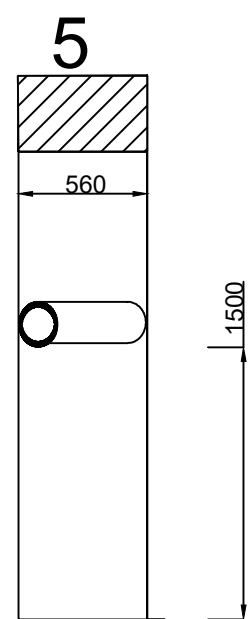
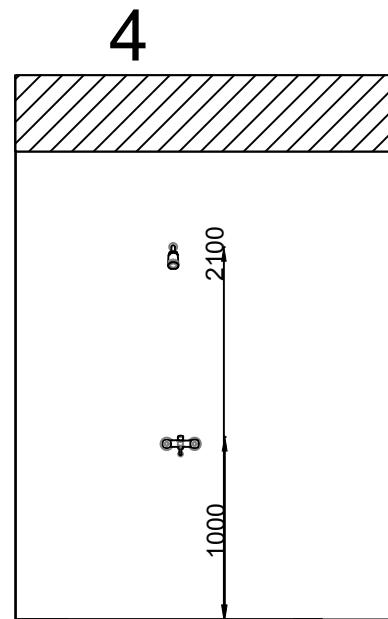
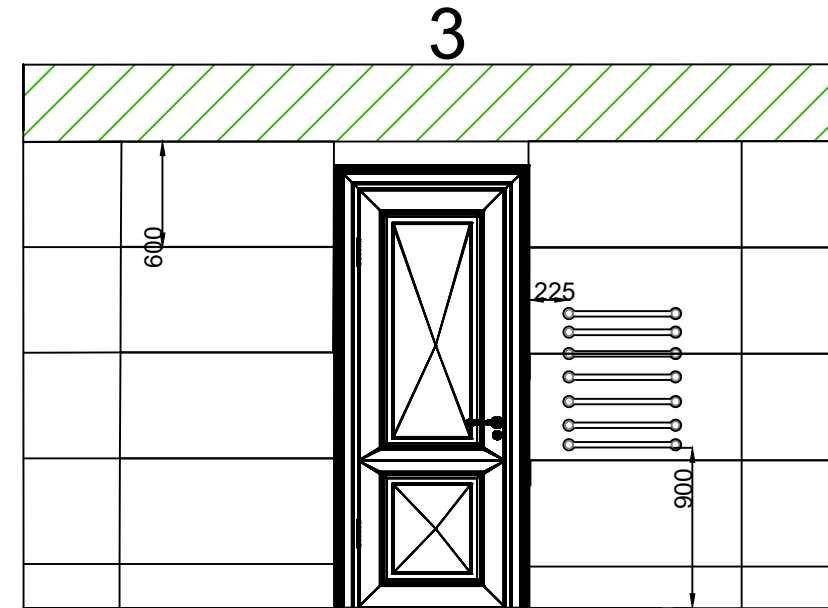
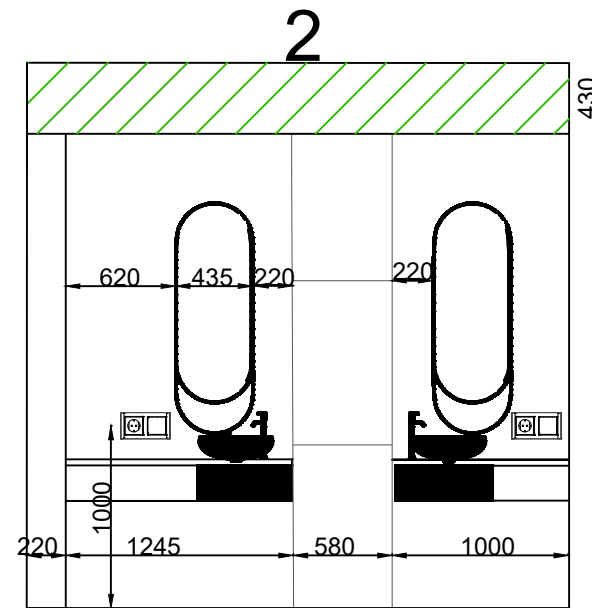
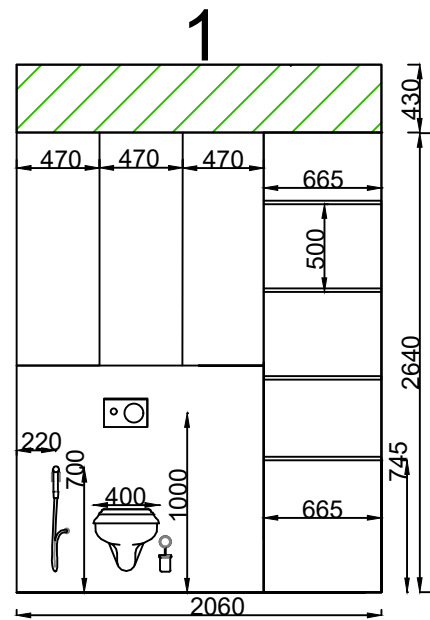

Apartment Design Project		Our address 16 Abovyan	
Founder	A. Danielyan	page quantity	page number
Teacher	M. Yeghyan	39	16
Student	A. Khanikyan	« ARMAT Design School »	

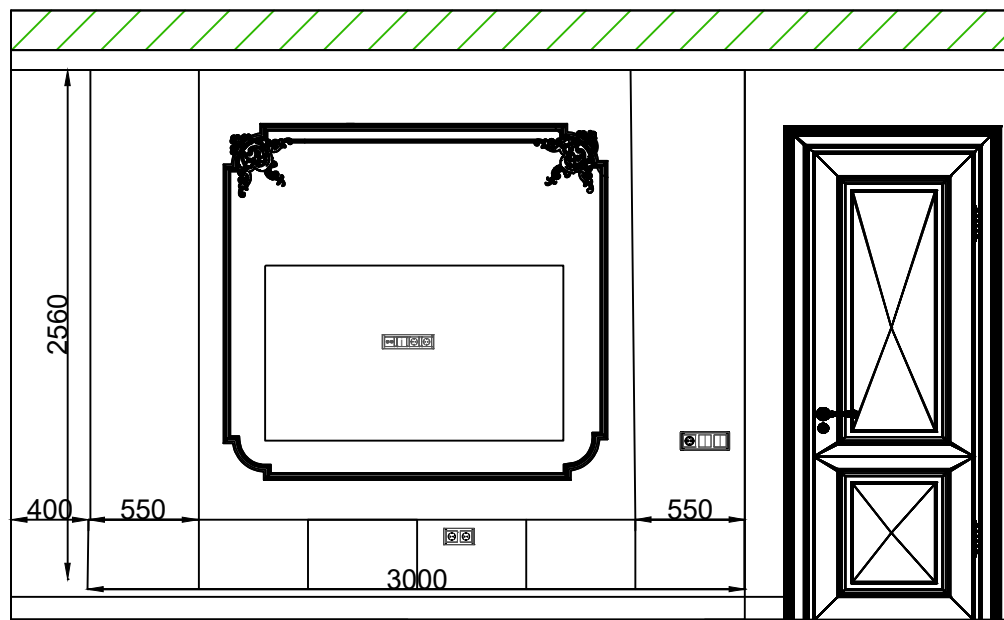

TV shelf

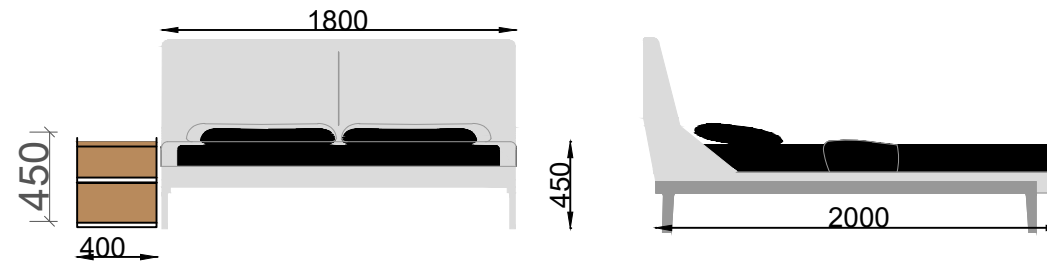
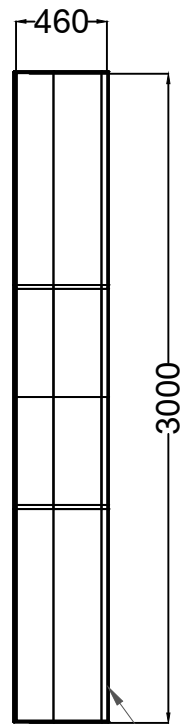

Bed

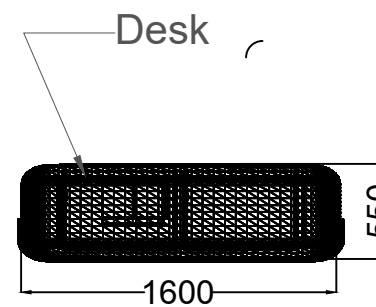
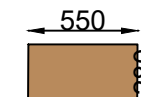
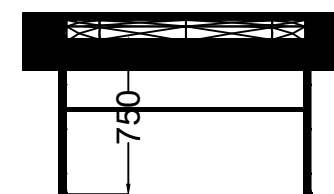
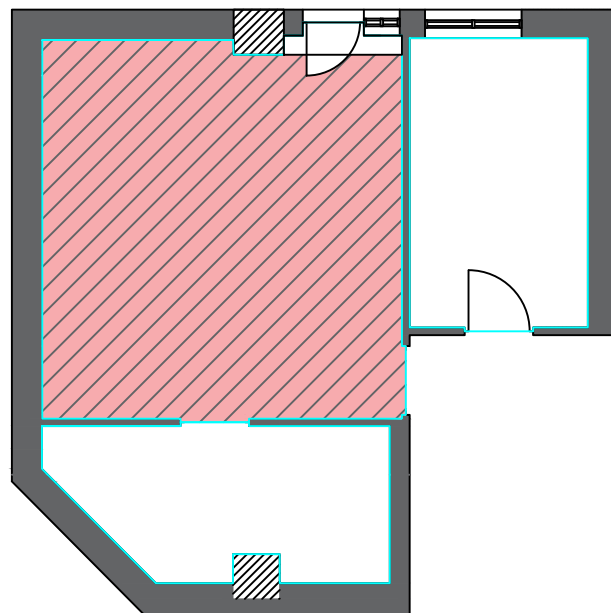
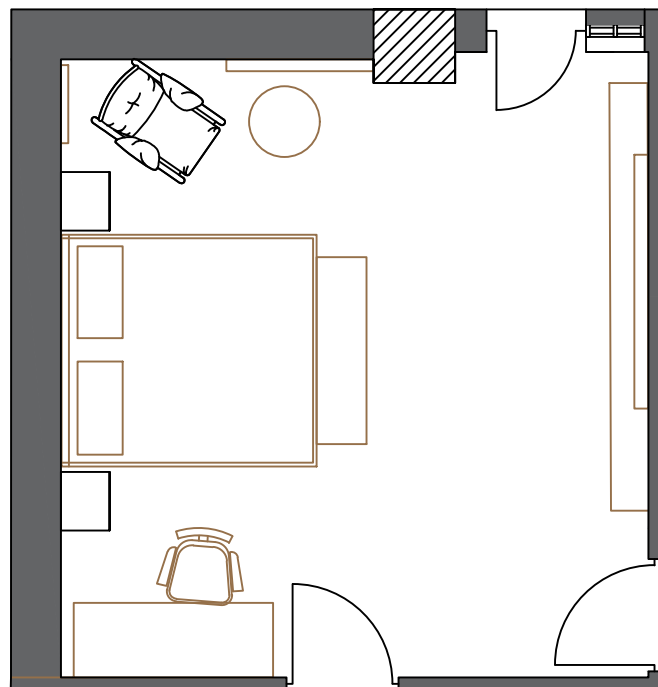
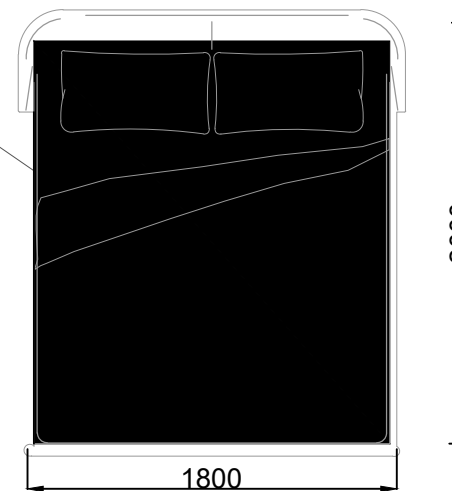





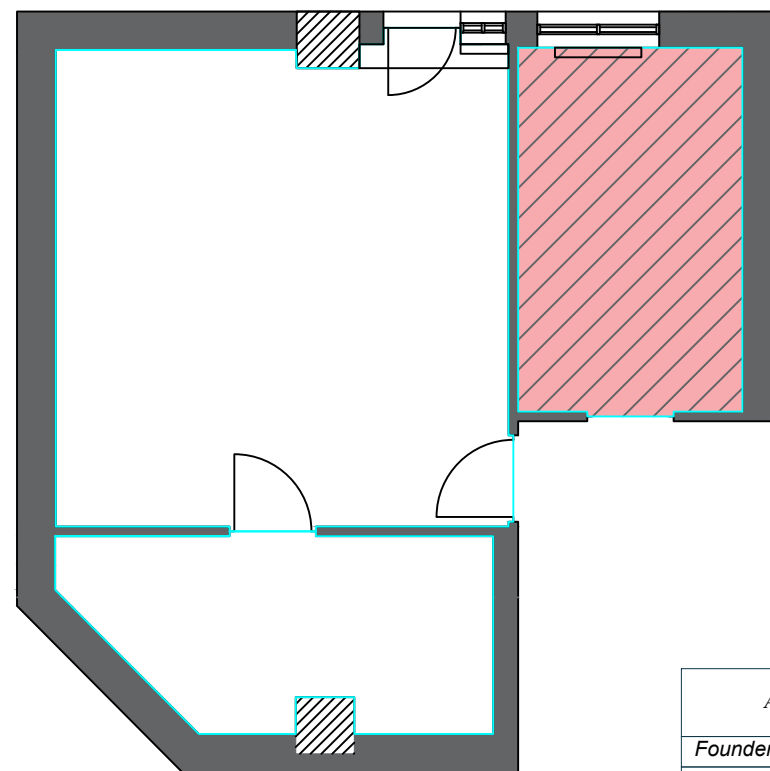
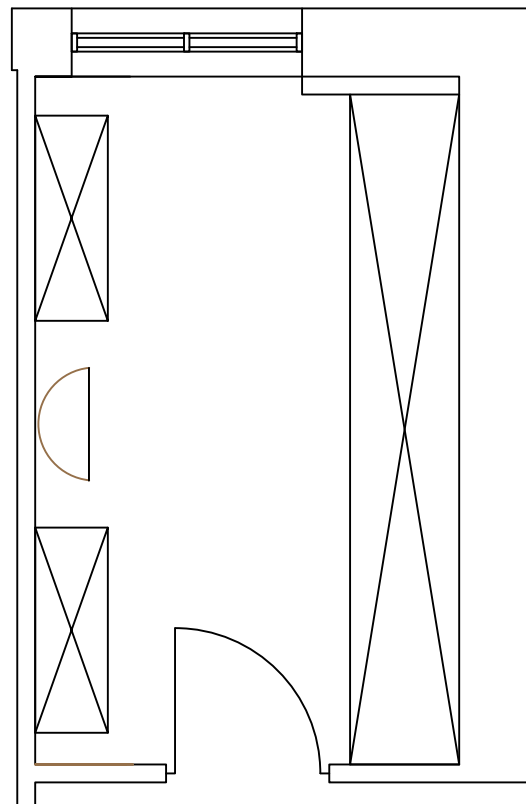
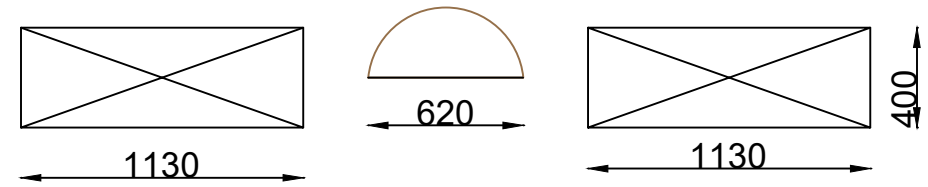
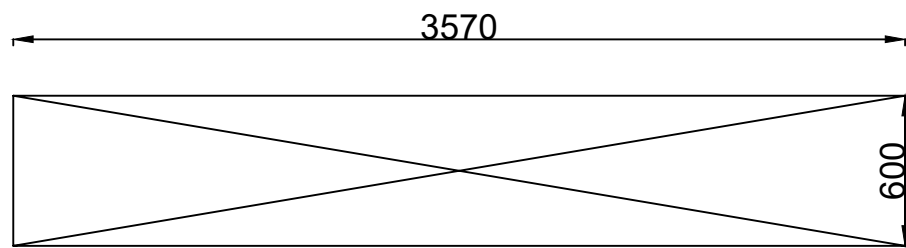
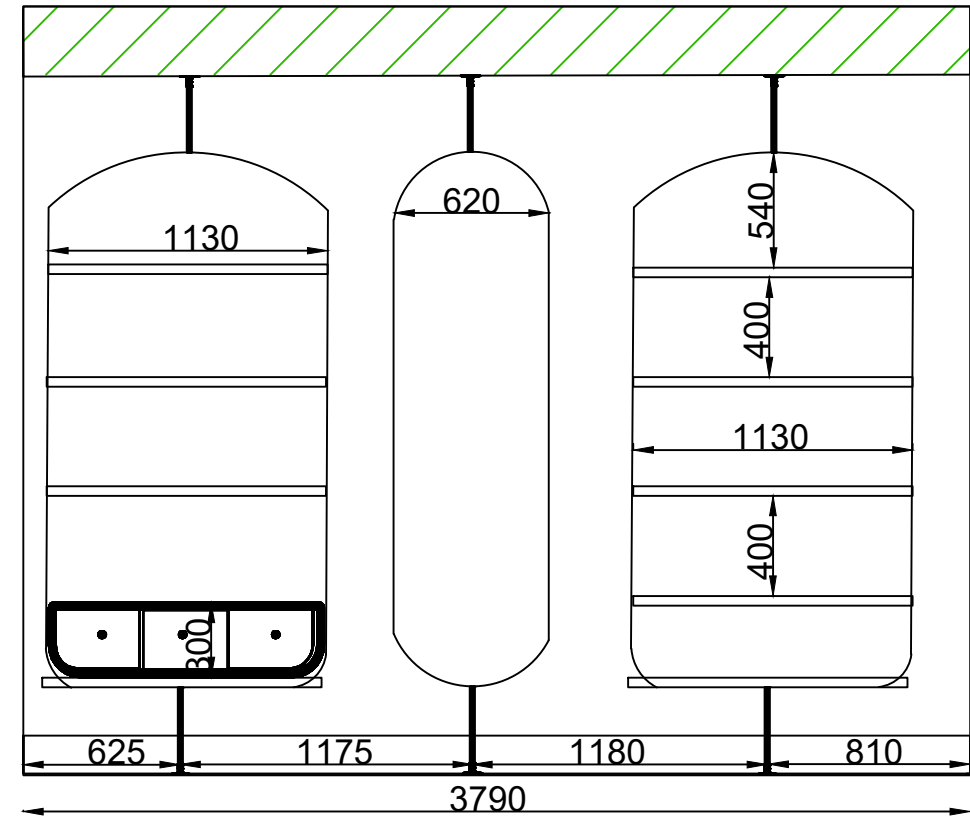
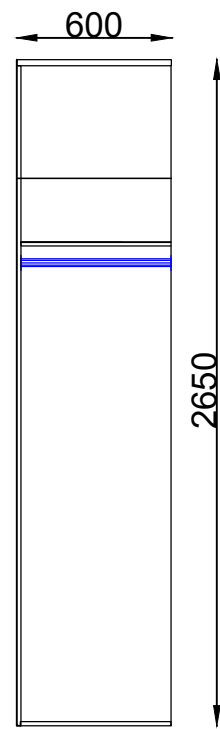
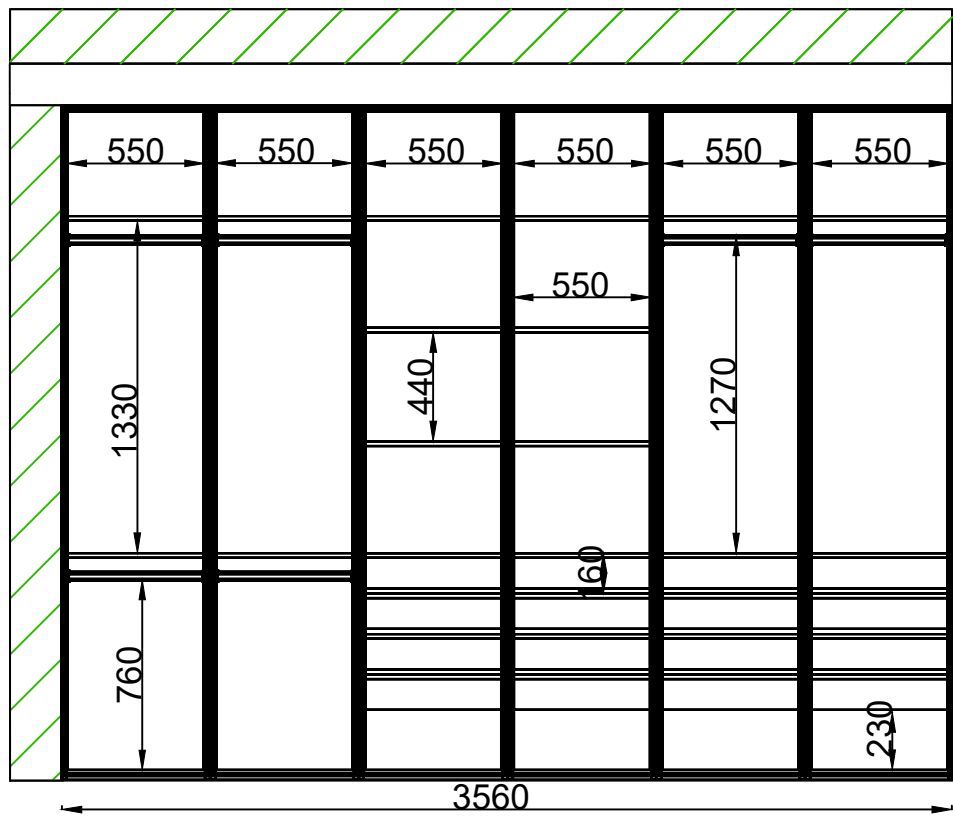





Desk



Apartment Design Project		Our address 16 Abovyan	
Founder	A. Danielyan	page quantity	page number
Teacher	M. Yeghyan	39	17
Student	A. Khanikyan	« ARMAT Design School »	



Apartment Design Project		Our address 16 Abovyan	
Founder	A. Danielyan	Electrical Layout Drawings	page quantity
Teacher	M. Yeghyan		39
Student	A. Khanikyan		page number
			18
« ARMAT Design School »			

Material

N	Material	Unit	Room			Total	Image
			①	②	③		
Floor							
1	wooden parquet American Walnut 125x640	m ²	23.5			23.5	
2	Wooden parquet American Walnut 125x640	m ²		9		9	
3	Keramogranit BOMOND Estatuario 1000x1000	m ²			8	8	
Ceiling							
4	Plasterboard	m ²	24	10	8	42	
5	Paint	m ²	24	10	8	42	
Wall							
6	Molding Dikart Frame 2	L/m	47.1			47.1	
7	Decorative paint	m ²	20.5	11		31.5	
8	Keramogranit BOMOND Arklam / once black 600x1200	m ²			2.5	2.5	
9	Keramogranit BOMOND Estatuario 600x1200	m ²			15.2	15.2	
10	Keramogranit BOMOND 80LK44P 600x1200	m ²			8.1	8.1	
11	Keramogranit BOMOND Arklam Chromatica Blue Silk 1200x1200	m ²			7.6	7.6	
12	Paint //	m ²	28	22		50	
13	Floor molding H150 mm	m ²	18.5	11.5		30	
Lighting							
14	Chandelier	piece	3			3	
15	Chandelier	piece		1		1	
16	Chandelier	piece			2	2	
17	Ceiling led lighting	L/m	4.6				
18	Profile led lighting	L/m	10.4	10.6	2.7	23.7	
19	Spot light	piece	20	8	12	40	
Electricity							
21	Standard narrow	piece	6	2	2	10	
22	Standard wide	piece	1	2	2	5	

N	Material	Unit	Room			Total	Image
			①	②	③		
23	Reverse	piece	2			2	
24	Plug	piece	11	2	2	14	
25	Internet	piece	1			1	

Apartment Design Project			Our address 16 Abovyan	
Founder	A. Danielyan	Detailing	page quantity	page number
Teacher	M. Yeghyan		39	19
Student	A. Khanikyan		« ARMAT Design School »	



<i>Apartment Design Project</i>		<i>Our address</i> 16 Abovyan	
<i>Founder</i>	<i>A. Danielyan</i>	<i>3 D Visualization</i>	<i>page quantity</i>
<i>Teacher</i>	<i>M. Yeghyan</i>		<i>page number</i>
<i>Student</i>	<i>A. Khanikyan</i>		39
			<i>« ARMAT Design School »</i>



<i>Apartment Design Project</i>		<i>Our address</i> 16 Abovyan	
<i>Founder</i>	A. Danielyan	<i>3 D Visualization</i>	<i>page quantity</i>
<i>Teacher</i>	M. Yeghyan		39
<i>Student</i>	A. Khanikyan		<i>page number</i>
			21
<i>« ARMAT Design School »</i>			



<i>Apartment Design Project</i>		<i>Our address</i> 16 Abovyan		
<i>Founder</i>	<i>A. Danielyan</i>	<i>3D Visualization</i>	<i>page quantity</i>	<i>page number</i>
<i>Teacher</i>	<i>M. Yeghyan</i>		39	22
<i>Student</i>	<i>A. Khanikyan</i>		<i>« ARMAT Design School »</i>	



<i>Apartment Design Project</i>		<i>Our address</i> 16 Abovyan	
<i>Founder</i>	A. Danielyan	<i>3D Visualization</i>	<i>page quantity</i>
<i>Teacher</i>	M. Yeghyan		39
<i>Student</i>	A. Khanikyan		<i>page number</i>
			23
<i>« ARMAT Design School »</i>			





Apartment Design Project		Our address 16 Abovyan	
Founder	A. Danielyan	3D Visualization	page quantity
Teacher	M. Yeghyan		page number
Student	A. Khanikyan		39
			« ARMAT Design School »



<i>Apartment Design Project</i>		<i>Our address</i> 16 Abovyan	
<i>Founder</i>	A. Danielyan	<i>3D Visualization</i>	<i>page quantity</i>
<i>Teacher</i>	M. Yeghyan		39
<i>Student</i>	A. Khanikyan		<i>page number</i> 25
			« ARMAT Design School »



<i>Apartment Design Project</i>		<i>Our address</i> 16 Abovyan	
<i>Founder</i>	<i>A. Danielyan</i>	<i>3D Visualization</i>	<i>page quantity</i>
<i>Teacher</i>	<i>M. Yeghyan</i>		<i>page number</i>
<i>Student</i>	<i>A. Khanikyan</i>		39
			<i>« ARMAT Design School »</i>



<i>Apartment Design Project</i>		<i>Our address</i> 16 Abovyan	
<i>Founder</i>	<i>A. Danielyan</i>	<i>3D Visualization</i>	<i>page quantity</i>
<i>Teacher</i>	<i>M. Yeghyan</i>		<i>page number</i>
<i>Student</i>	<i>A. Khanikyan</i>		39
			<i>« ARMAT Design School »</i>



Apartment Design Project

Founder	A. Danielyan
Teacher	M. Yeghyan
Student	A. Khanikyan

3D Visualization

Our address
16 Abovyan

page quantity	page number
39	28

« ARMAT Design School »



<i>Apartment Design Project</i>		<i>Our address</i> 16 Abovyan	
<i>Founder</i>	A. Danielyan	<i>3D Visualization</i>	<i>page quantity</i>
<i>Teacher</i>	M. Yeghyan		39
<i>Student</i>	A. Khanikyan		<i>page number</i> 29
			« ARMAT Design School »



<i>Apartment Design Project</i>		<i>Our address</i> 16 Abovyan	
<i>Founder</i>	A. Danielyan	<i>3D Visualization</i>	<i>page quantity</i>
<i>Teacher</i>	M. Yeghyan		39
<i>Student</i>	A. Khanikyan		<i>page number</i> 30
			« ARMAT Design School »



<i>Apartment Design Project</i>		<i>Our address</i> 16 Abovyan	
<i>Founder</i>	A. Danielyan	<i>3D Visualization</i>	<i>page quantity</i>
<i>Teacher</i>	M. Yeghyan		39
<i>Student</i>	A. Khanikyan		<i>page number</i> 31
			« ARMAT Design School »



Apartment Design Project

Our address
16 Abovyan

Founder	A. Danielyan
Teacher	M. Yeghyan
Student	A. Khanikyan

3D Visualization

page quantity	page number
39	32
« ARMAT Design School »	



Apartment Design Project

Our address
16 Abovyan

Founder	A. Danielyan
Teacher	M. Yeghyan
Student	A. Khanikyan

3D Visualization

page quantity	page number
39	33
« ARMAT Design School »	



Apartment Design Project

Our address
16 Abovyan

Founder	A. Danielyan
Teacher	M. Yeghyan
Student	A. Khanikyan

3D Visualization

page quantity	page number
39	34
« ARMAT Design School »	



Apartment Design Project

Our address
16 Abovyan

Founder	A. Danielyan
Teacher	M. Yeghyan
Student	A. Khanikyan

3D Visualization

page quantity	page number
39	35
« ARMAT Design School »	



Apartment Design Project

Our address
16 Abovyan

Founder	A. Danielyan
Teacher	M. Yeghyan
Student	A. Khanikyan

3D Visualization

page quantity	page number
39	36
« ARMAT Design School »	



Apartment Design Project

Our address
16 Abovyan

Founder	A. Danielyan
Teacher	M. Yeghyan
Student	A. Khanikyan

3D Visualization

page quantity	page number
39	37
« ARMAT Design School »	



Apartment Design Project

16 Abovyan

Founder	A. Danielyan	3D Visualization	page quantity	page number
Teacher	M. Yeghyan		39	37
Student	A. Khanikyan		« ARMAT Design School »	





Apartment Design Project

Our address
16 Abovyan

Founder	A. Danielyan
Teacher	M. Yeghyan
Student	A. Khanikyan

3 D Visualization

page quantity	page number
39	39
« ARMAT Design School »	



ARMAT
DESIGN SCHOOL

+(374) 55 70 73 33
www.armatdesign.am