



DESIGN PROJECT

PRIVATE HOUSE

STUDENT SHUSHAN VOSKANYAN

YEREVAN2024

1. Existing floor plan.....3

2. Wall Drawings .....4

3.Furniture Layout Drawings .....5

4.Electrical Layout Drawings .....6

5.False ceiling plan .....7

6.Floor covering plan .....8

7.Floor heating .....9

9.Plumbing Layout Drawings.....10

10 Wall Layout Drawings .....11-18

11 3D visualization.....19-35

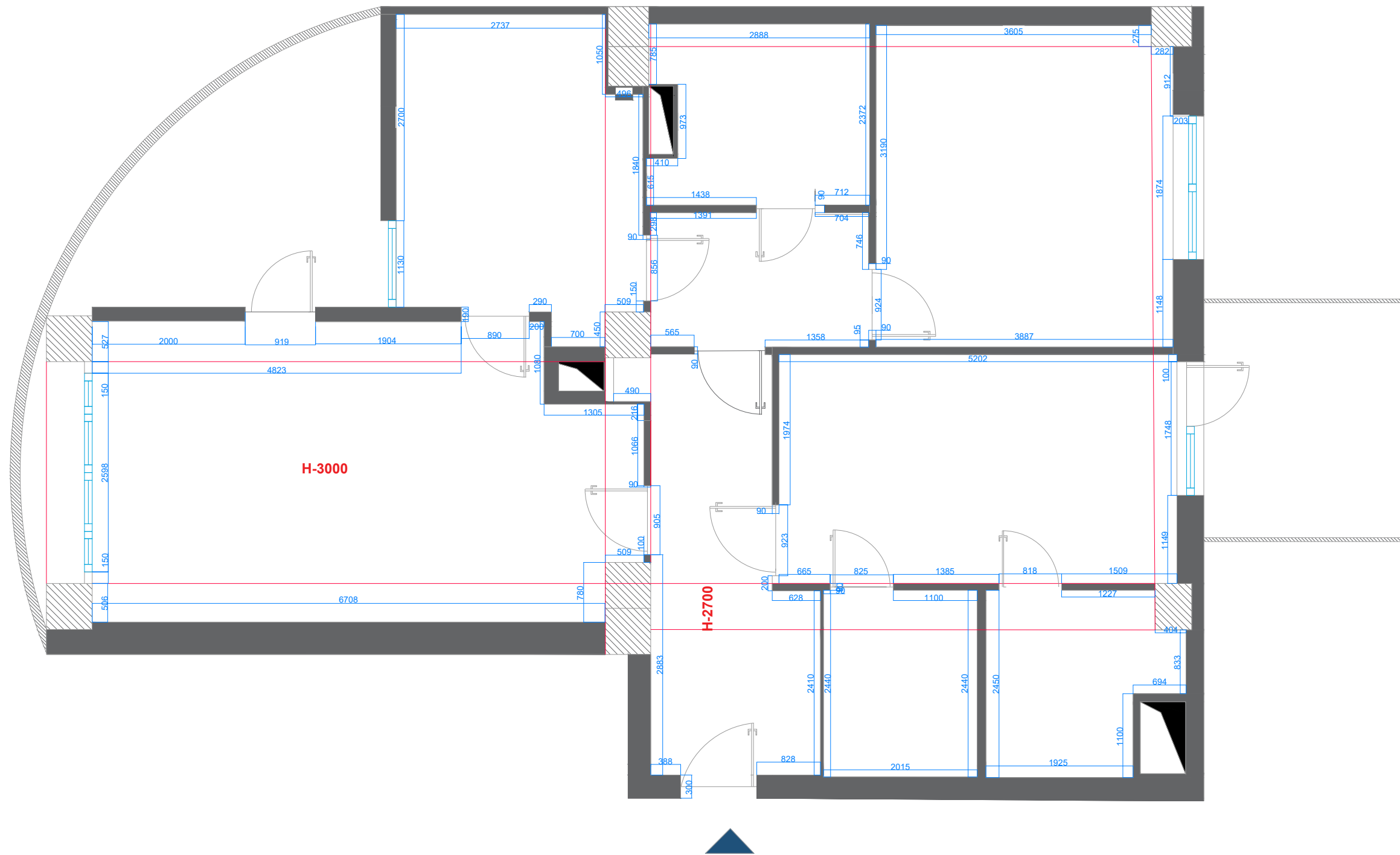

<i>APARTMENT DESIGN PROJECT</i>			Our address 16 Abovyan	
Founder	A. Danielyan	Existing floor plan	pages quantity	page number
Teacher	D. Gevorgyan		35	3
Student	S. Voskanyan		<i>"ARMAT Design School"</i>	

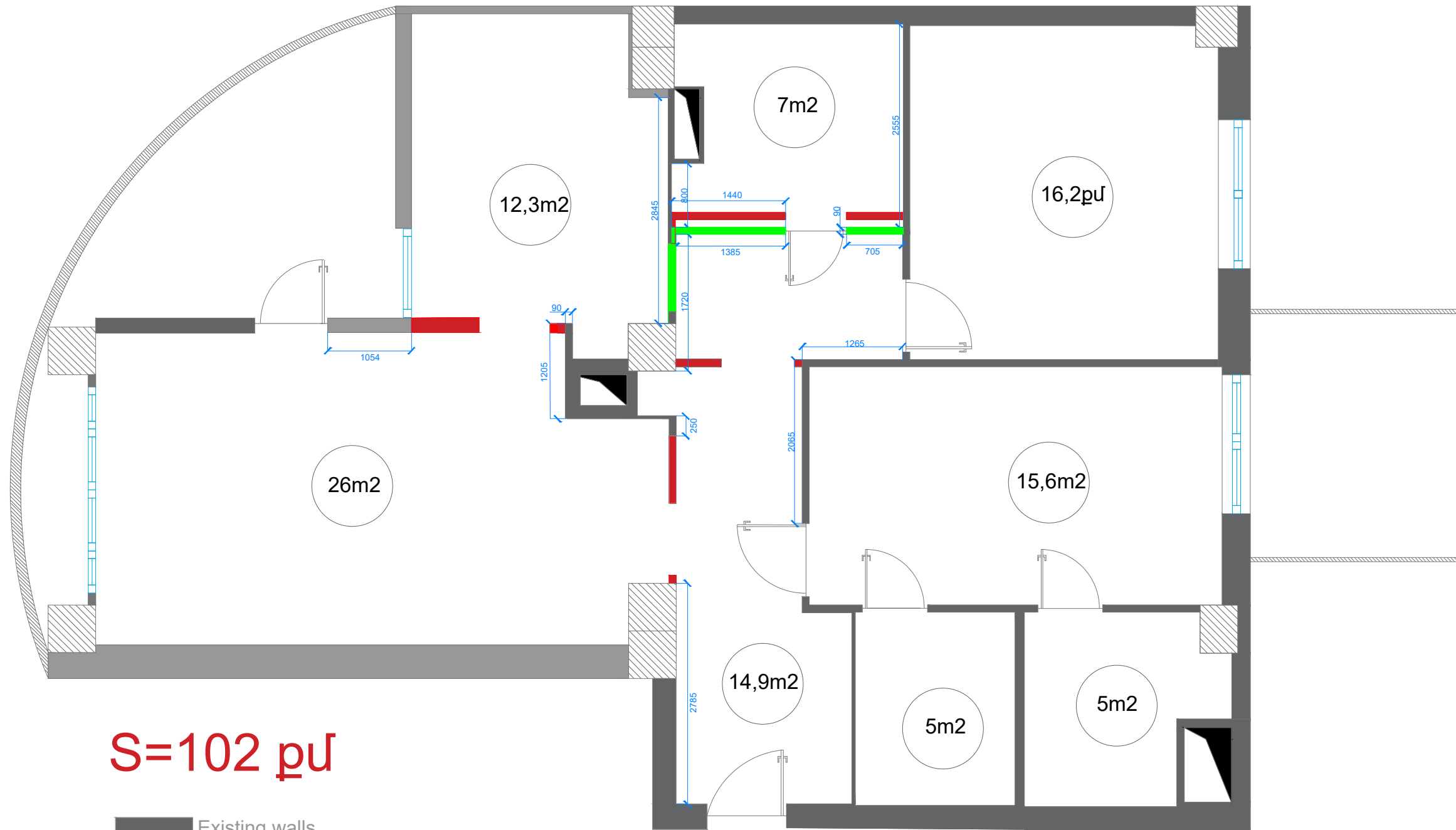

**S=102 pU**

- Existing walls
- Demolition plan
- Built walls

APARTMENT DESIGN PROJECT			Our address 16 Abovyan	
Founder	A. Danielyan	Demolition and built walls plan	pages quantity	page number
Teacher	D.Gevorgyan		39	4
Student	S. Voskanyan		"ARMAT Design School"	



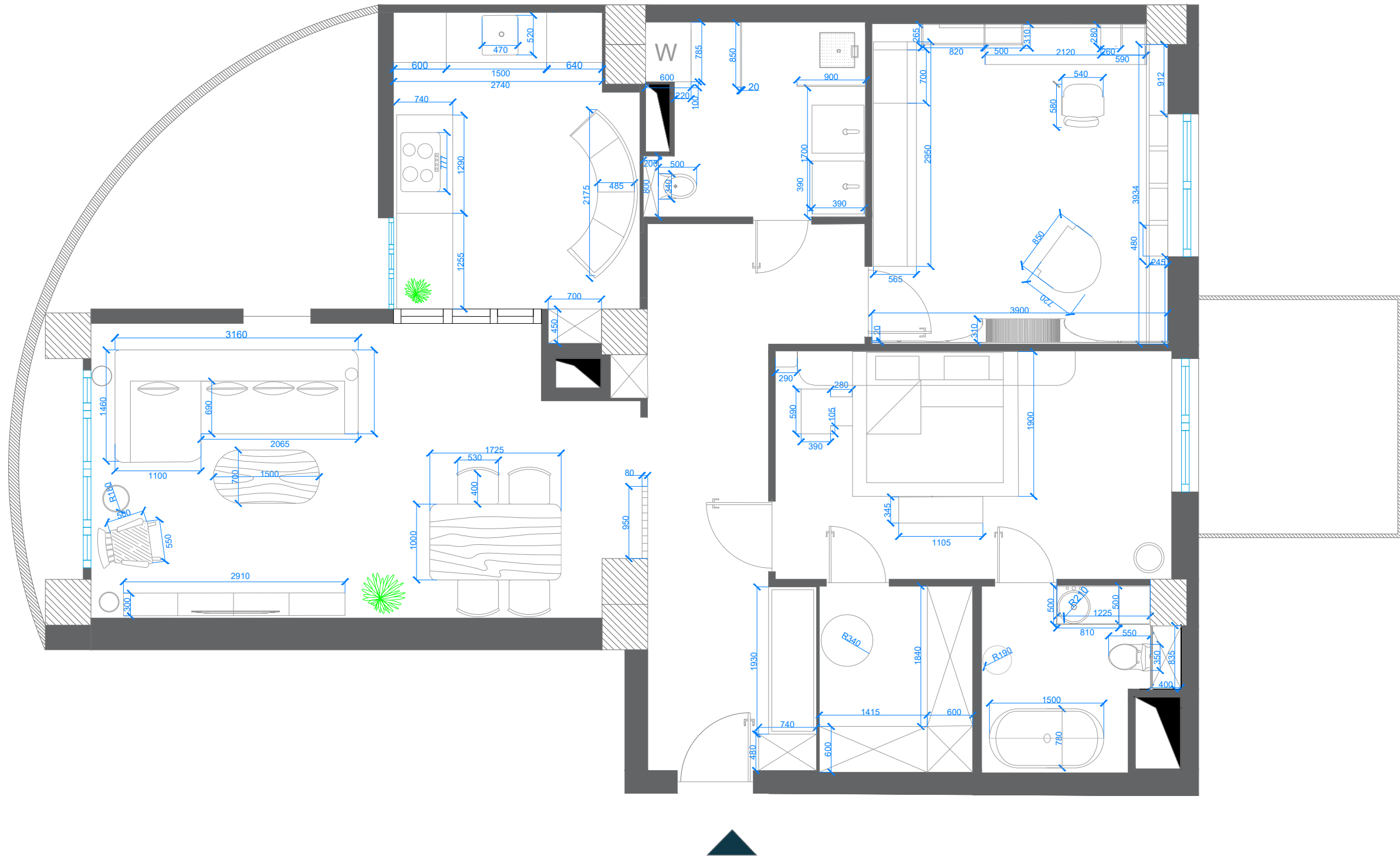



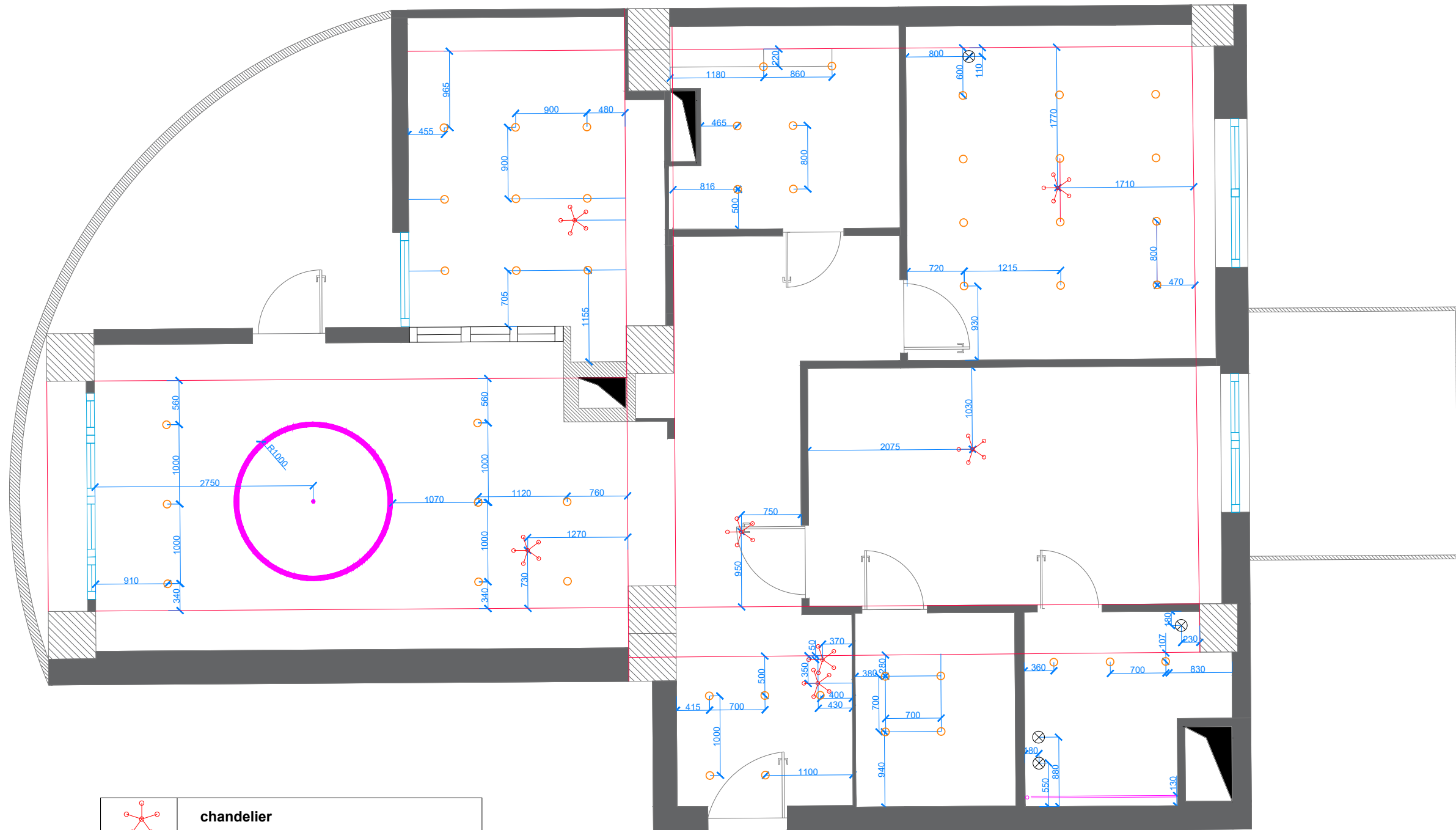

APARTMENT DESIGN PROJECT			Our address 16 Abovyan	
Founder	A. Danielyan	Existing floor plan	pages quantity	page number
Teacher	D. Gevorgyan		39	5
Student	S. Voskanyan		"ARMAT Design School"	

+(374) 55 70 73 33  
www.armatdesign.am





	<b>chandelier</b>
	<b>spot light</b>
	<b>lamp</b>
	<b>neon light</b>

<i>Apartment Design Project</i>	
Founder	A. Danielyan
Teacher	D. Grigoryan
Student	S. Voskanyan

*Electrical Layout Drawings*

<i>Our address</i> 16 Abovyan	
<i>page quantity</i>	<i>page number</i>
39	6
« ARMAT Design School »	



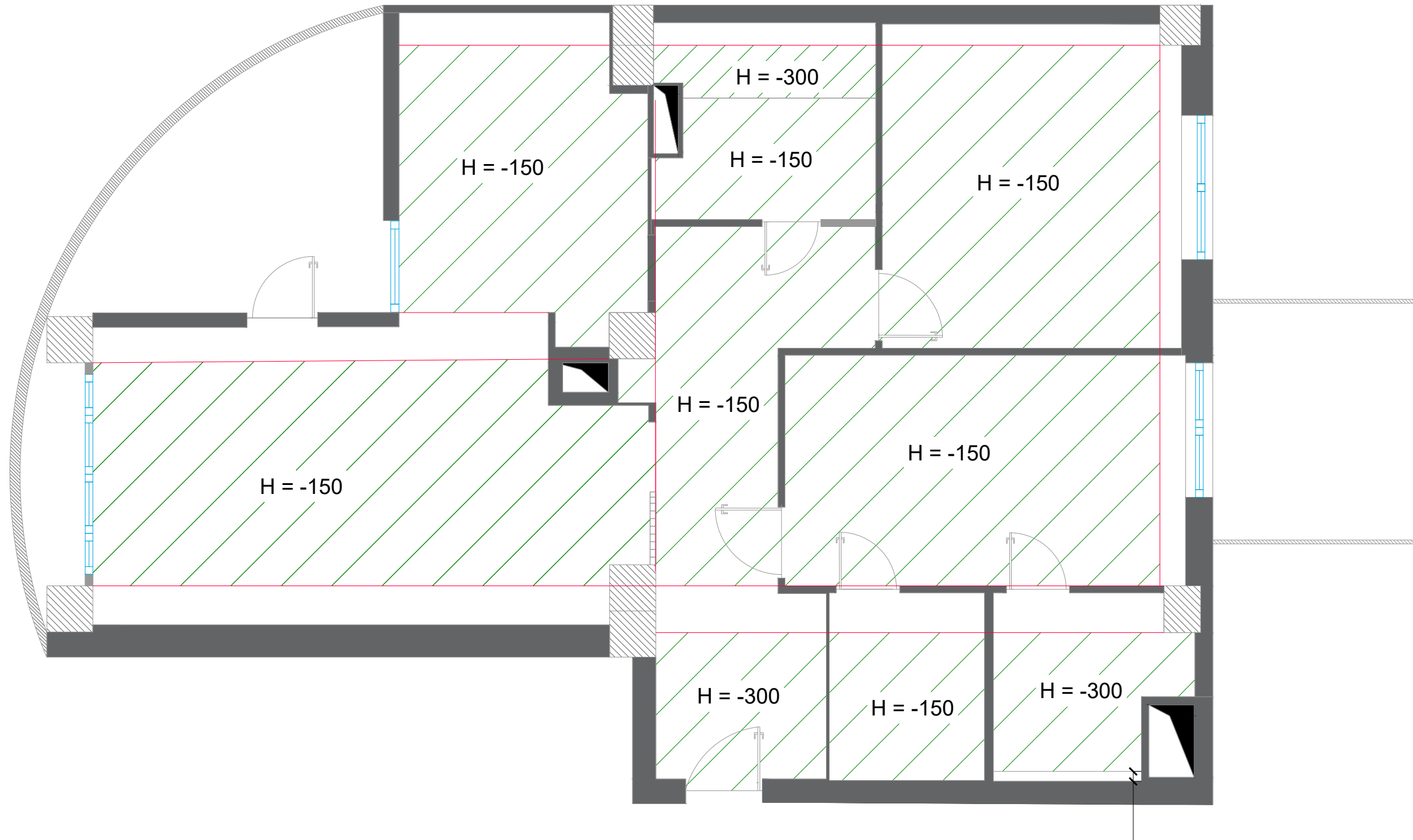

Apartment Design Project

Founder	A. Danielyan
Teacher	D. Grigoryan
Student	S. Voskanyan

Ceiling plan

Our address  
16 Abovyan

page quantity	page number
39	7
« ARMAT Design School »	



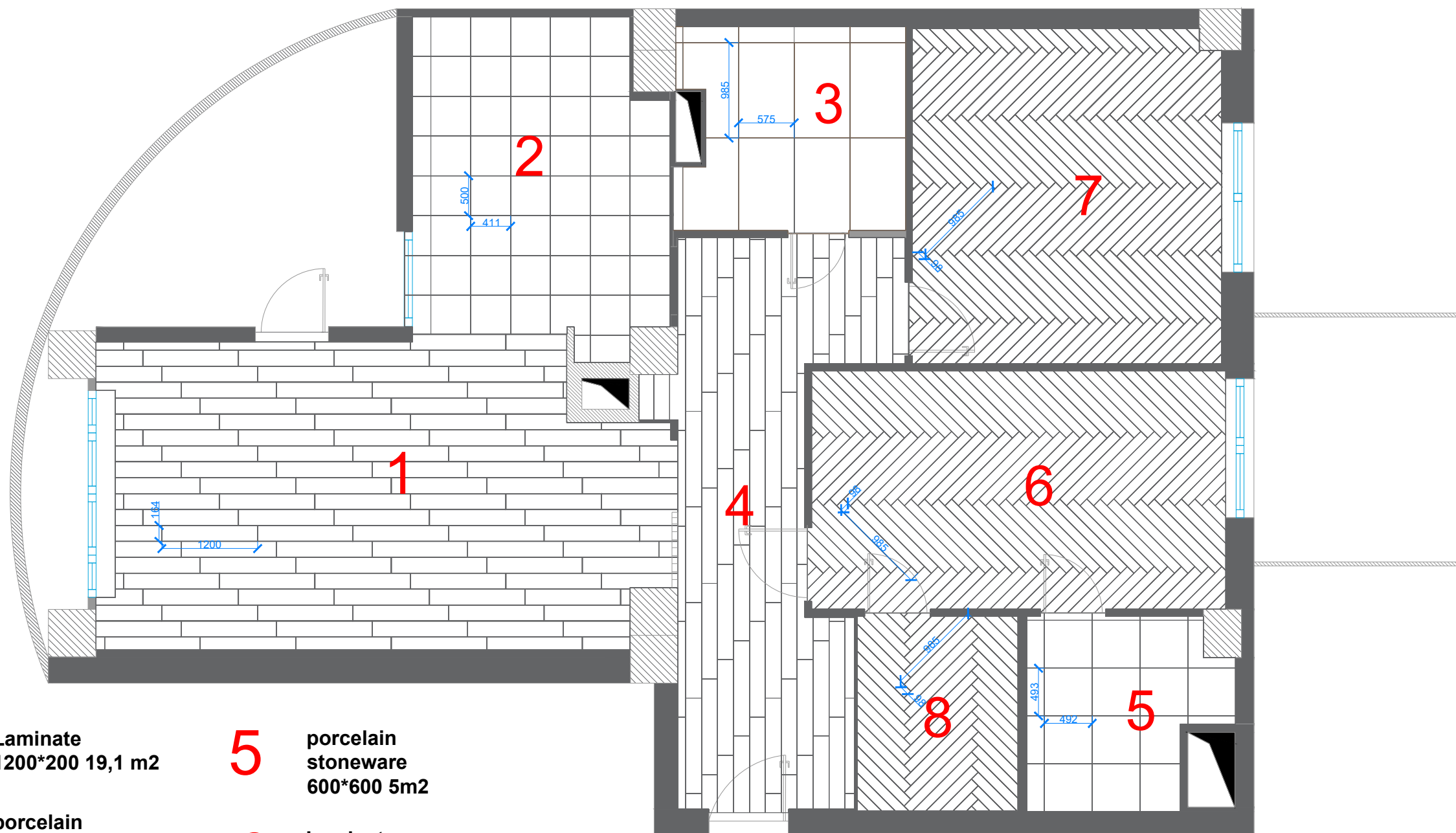

**1** Laminate  
1200\*200 19,1 m2

**5** porcelain  
stoneware  
600\*600 5m2

**2** porcelain  
stoneware  
500\*500 12,3 m2

**6** Laminate  
1200\*120 15,6 m2

**3** porcelain  
stoneware  
1200\*700 7 m2

**7** Laminate  
1200\*120 16,2  
m2

**4** porcelain  
stoneware  
1200\*200 14,9m2

**8** Laminate  
1200\*120 5 m2

Founder	A. Danielyan	Floor plan
Teacher	D. Grigoryan	
Student	S.Voskanyan	

Our address  
16 Abovyan  
page quantity 39 page number 8  
« ARMAT Design School»



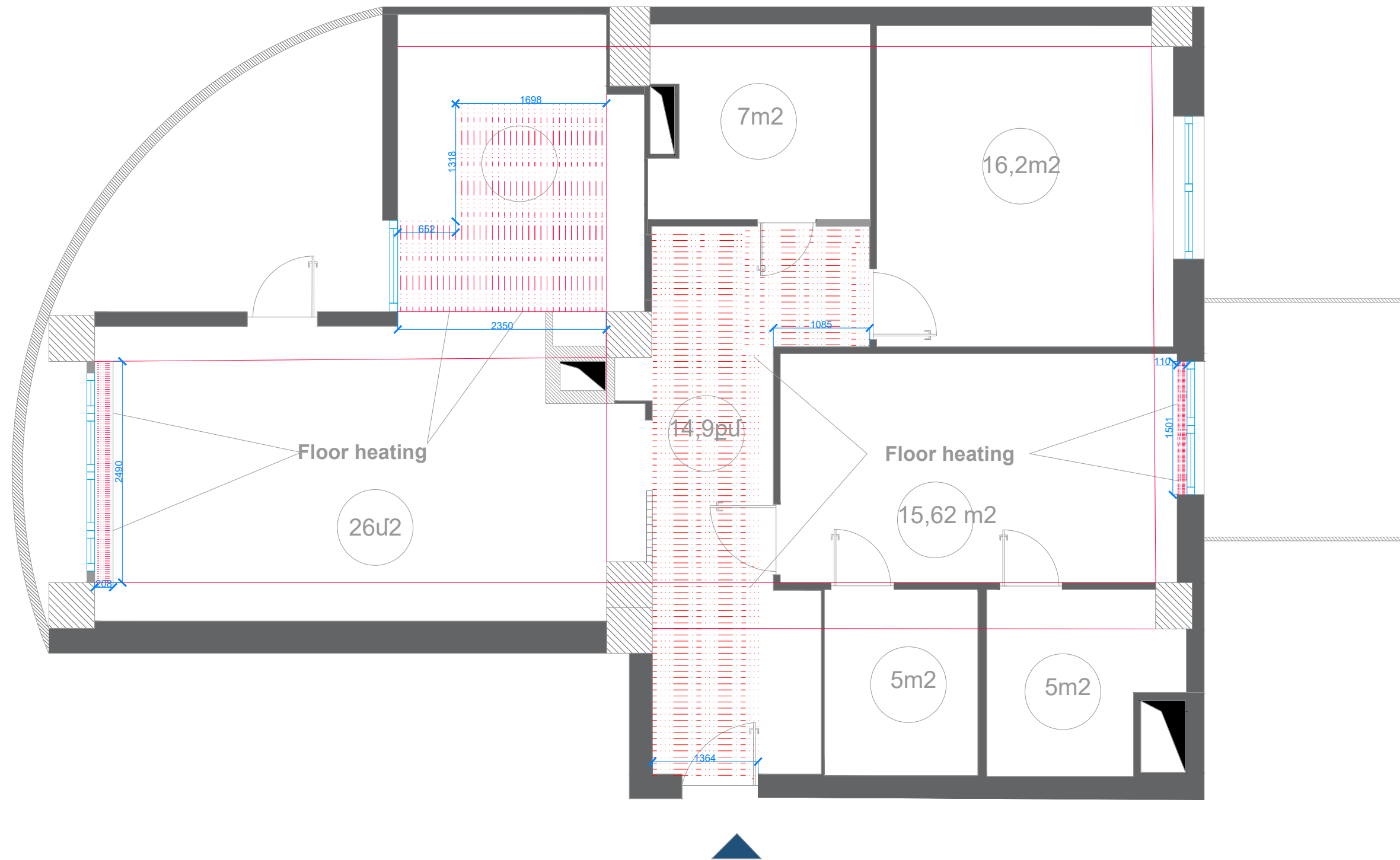

Founder	A. Danielyan
Teacher	D. Grigoryan
Student	S. Voskanyan

3 D Visualization

Our address  
16 Abovyan  
page quantity 39  
page number 9  
« ARMAT Design School »



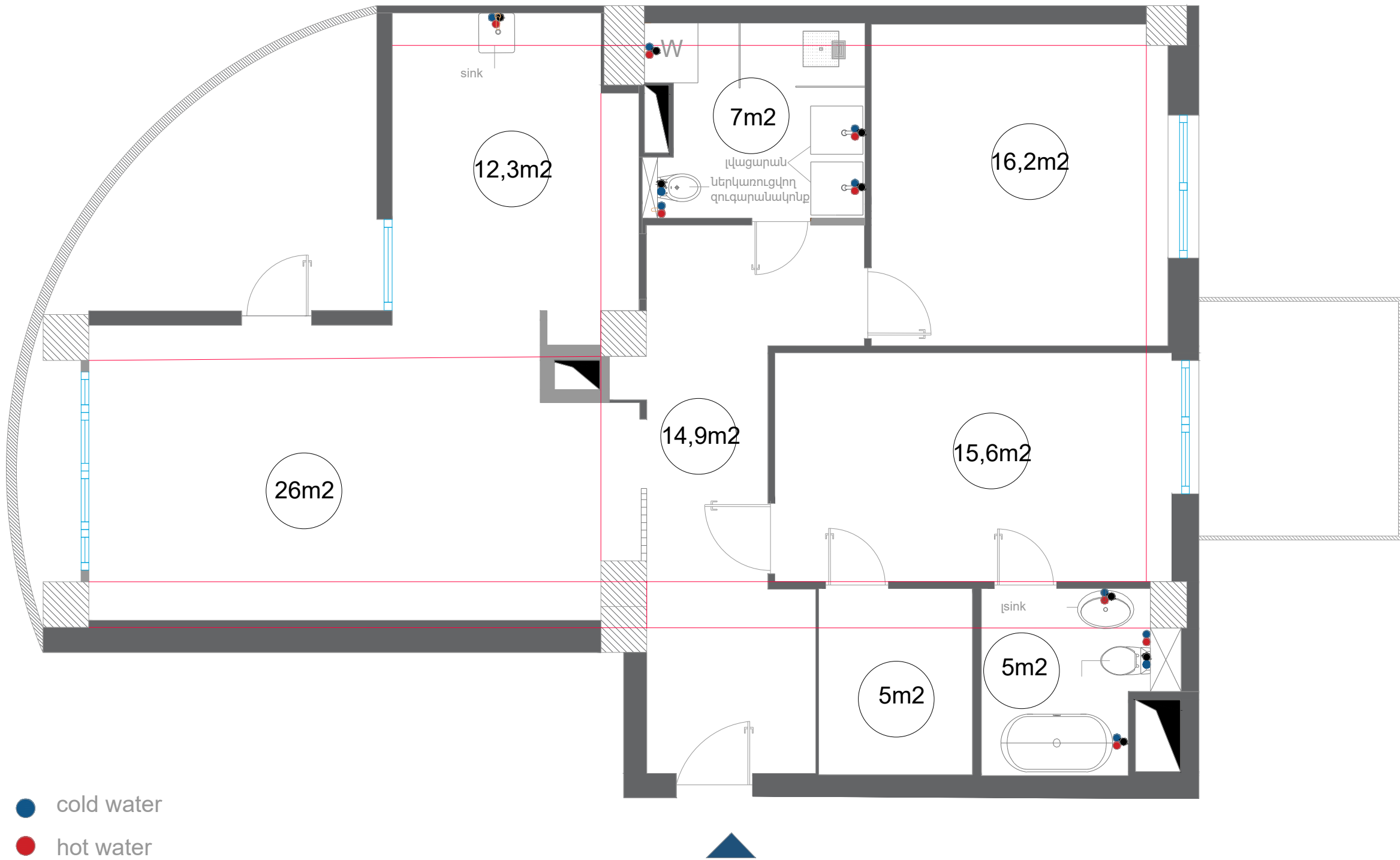

- cold water
- hot water
- Sewerage

Founder	A. Danielyan
Teacher	D. Grigoryan
Student	S. Voskanyan

3 D Visualization

Our address 16 Abovyan	
page quantity	page number
39	10
« ARMAT Design School »	

+(374) 55 70 73 33  
www.armatdesign.am

10

**ARMAT**  
DESIGN SCHOOL





**Նախասրահ**

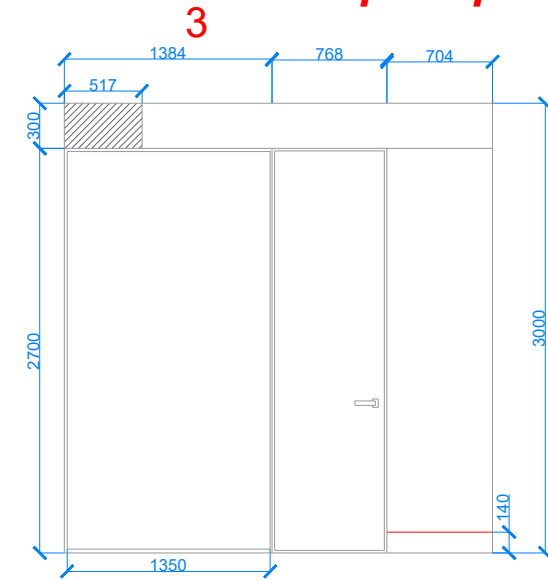
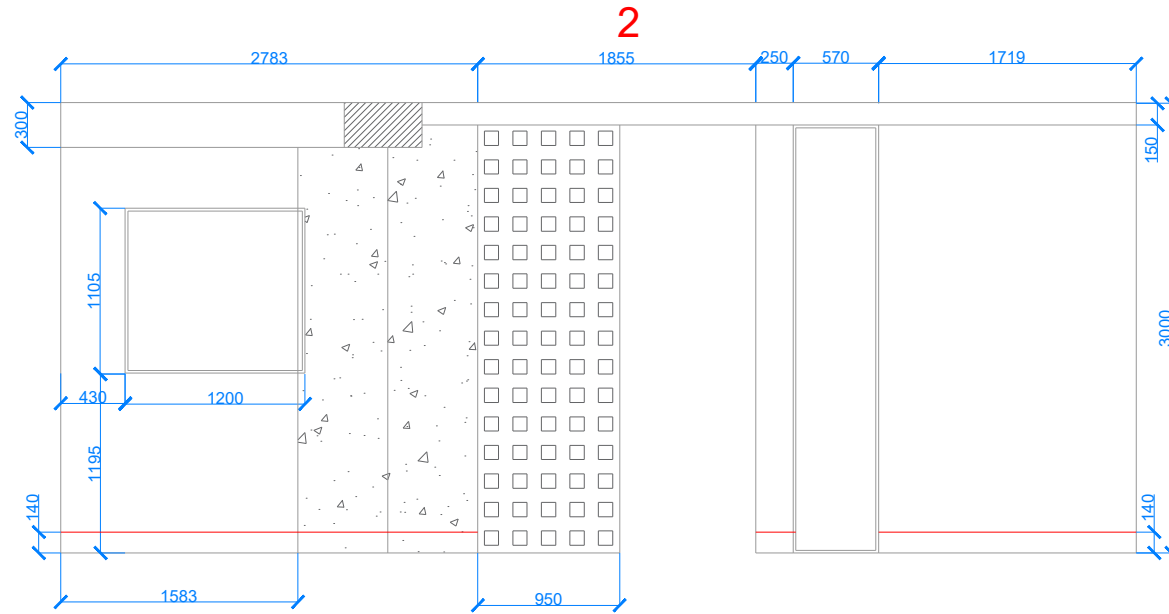
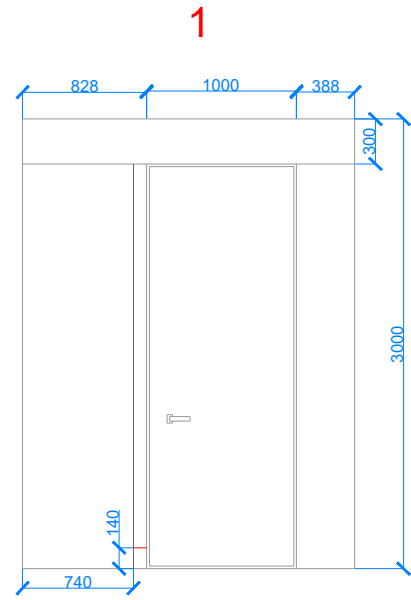

4

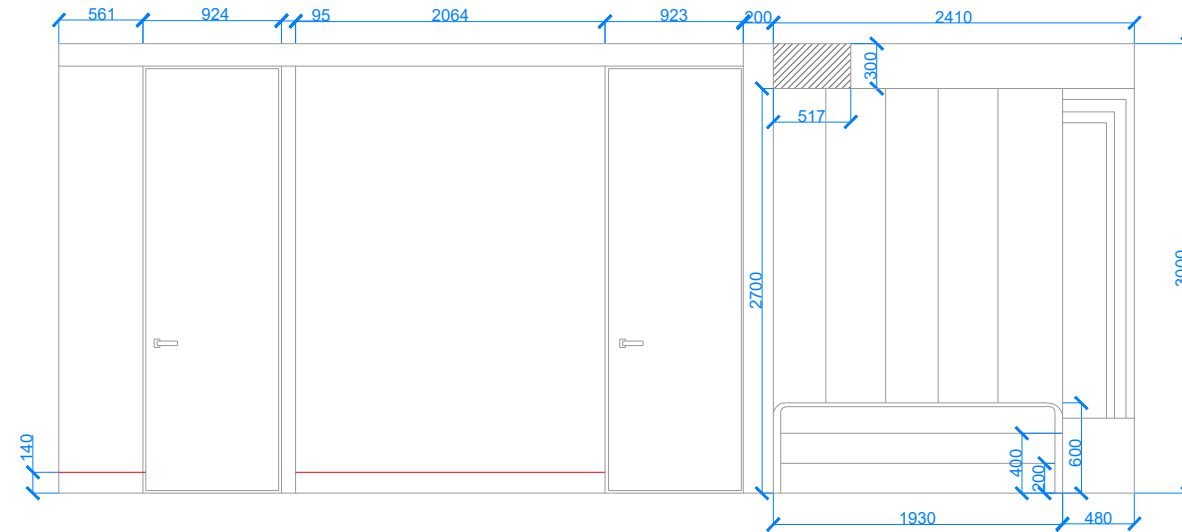
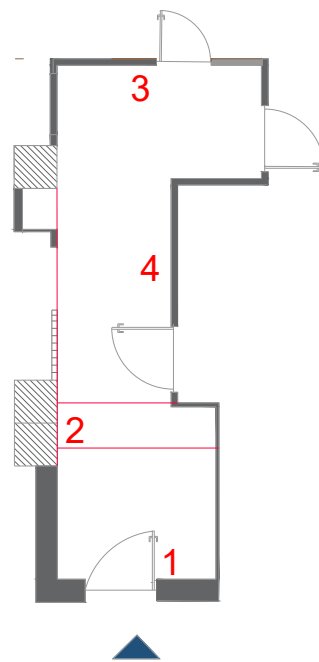
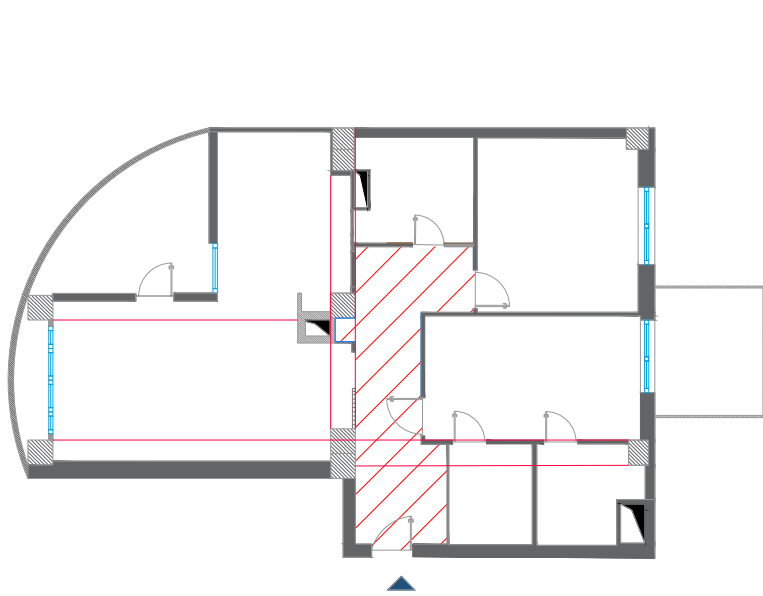

+(374) 55 70 73 33  
www.armatdesign.am

11

**ARMAT**  
DESIGN SCHOOL

Founder	A. Danielyan	3 D Visualization
Teacher	D. Grigoryan	
Student	S. Voskanyan	

Our address	16 Abovyan
page quantity	39
page number	11
« ARMAT Design School »	



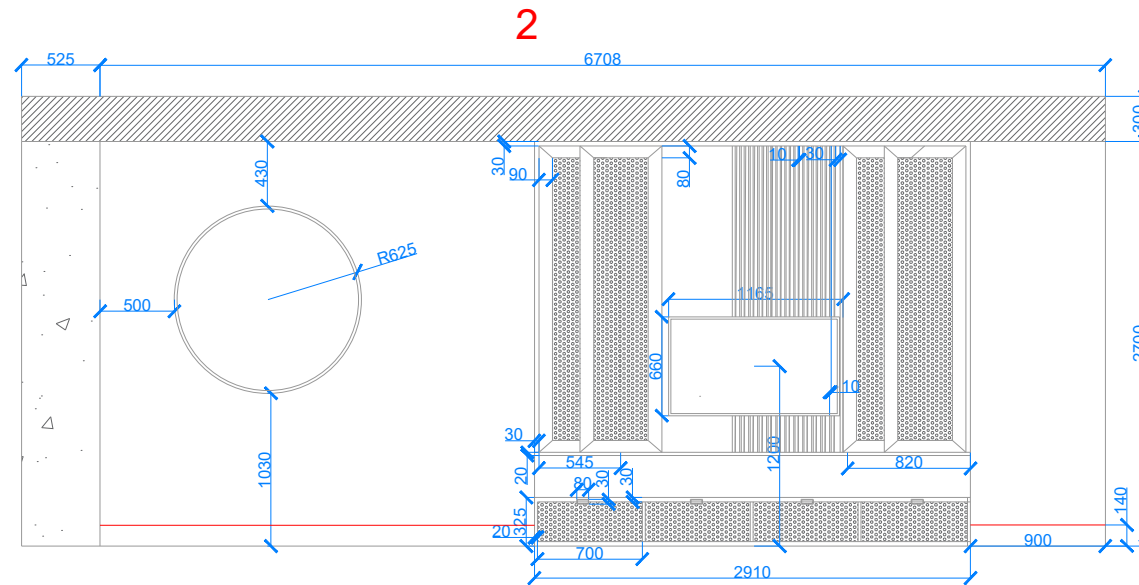
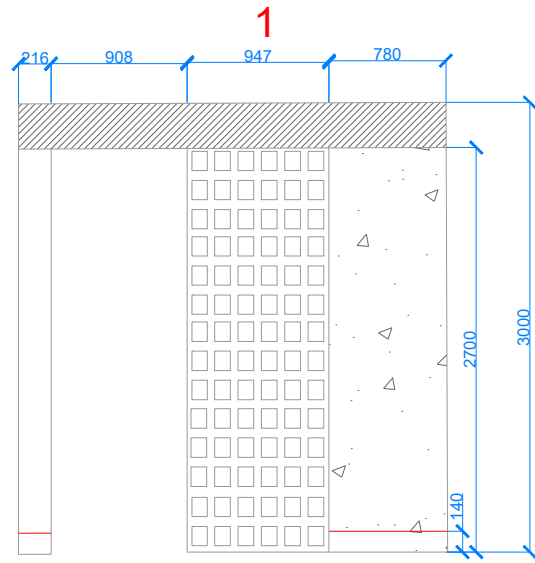

**Sitting room**

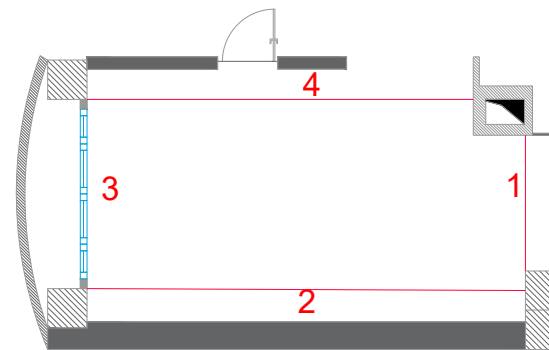
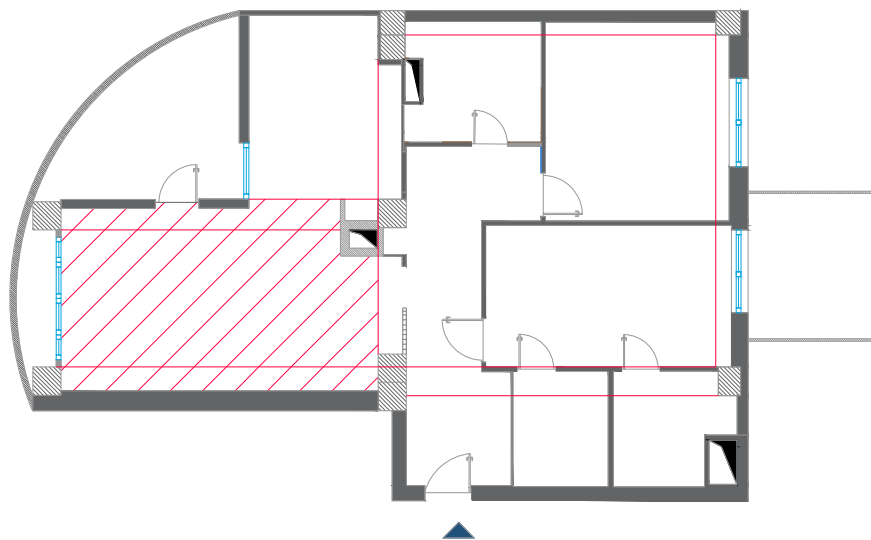
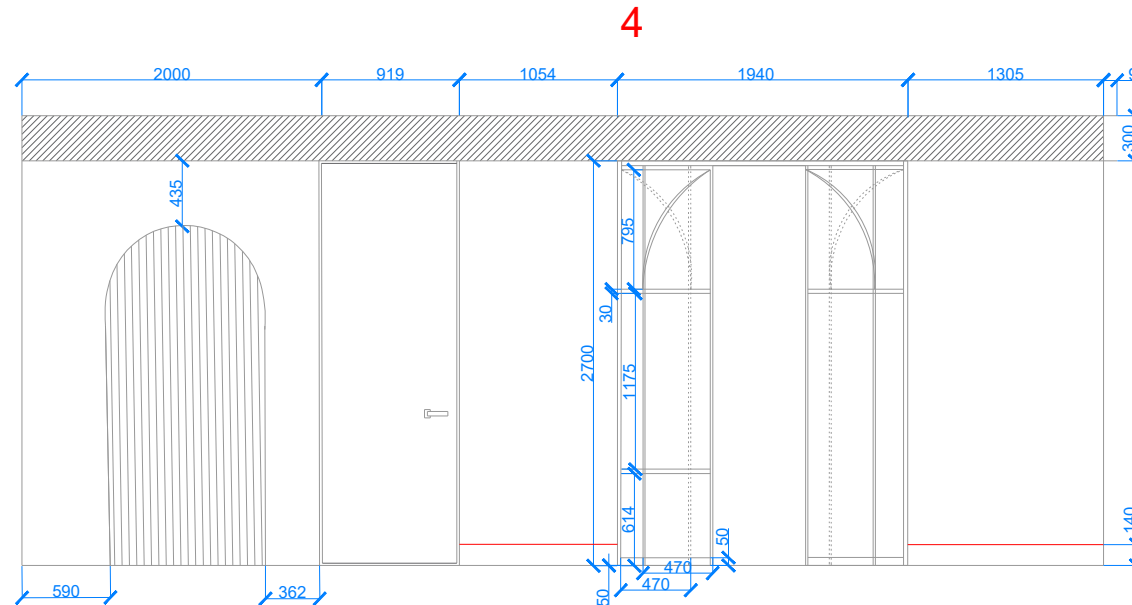
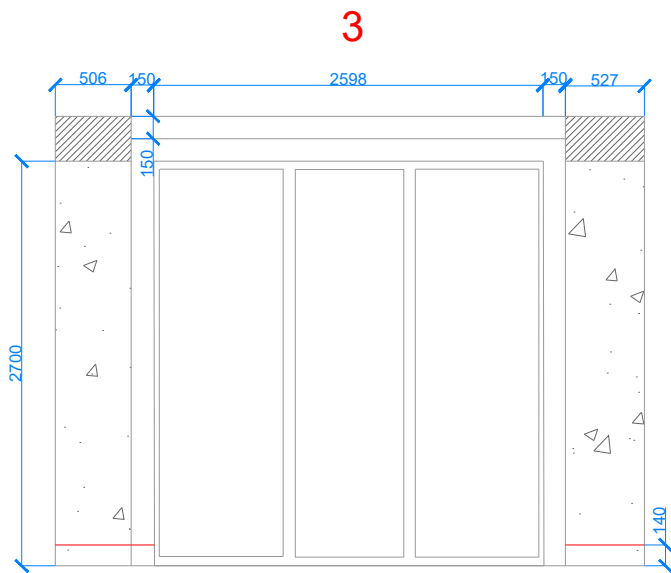

Founder	A. Danielyan
Teacher	D. Grigoryan
Student	S. Voskanyan

3 D Visualization

Our address	16 Abovyan
page quantity	39
page number	12
« ARMAT Design School »	

1

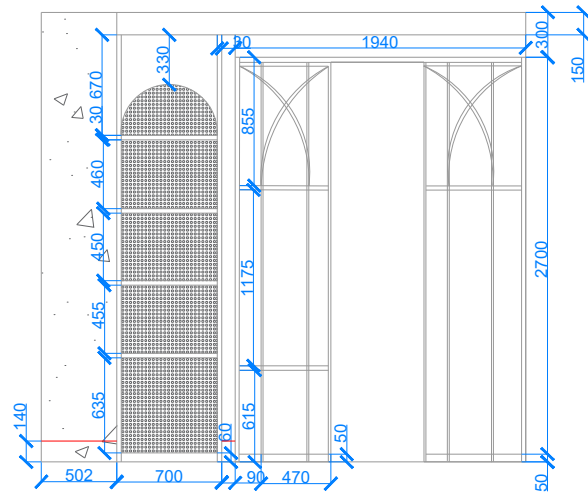

2

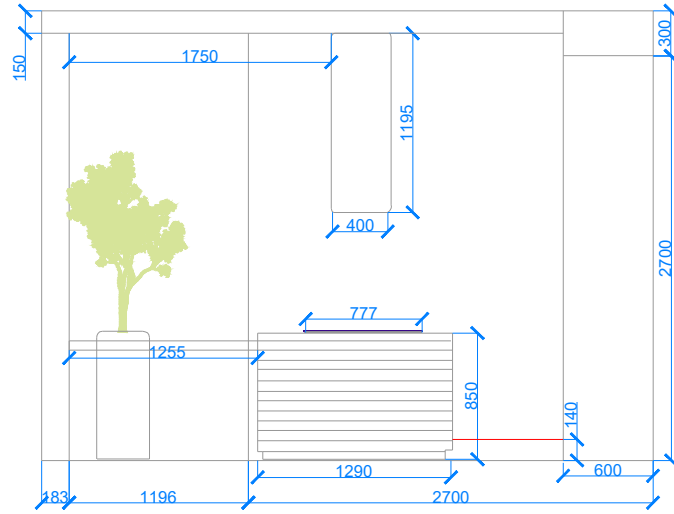

3

kitchen

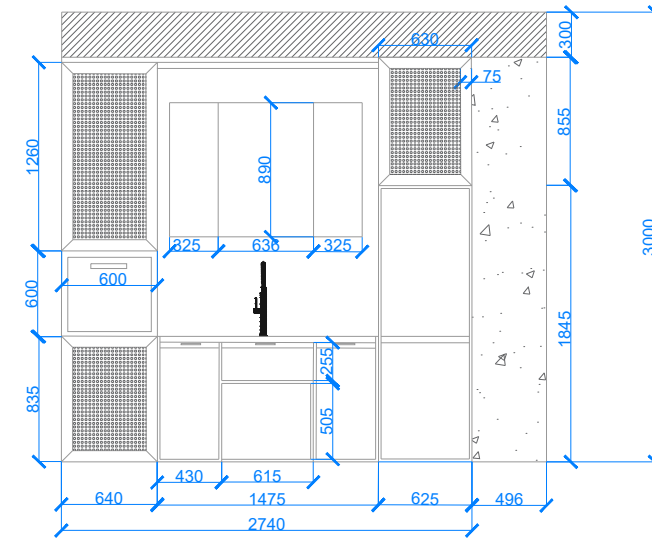

4

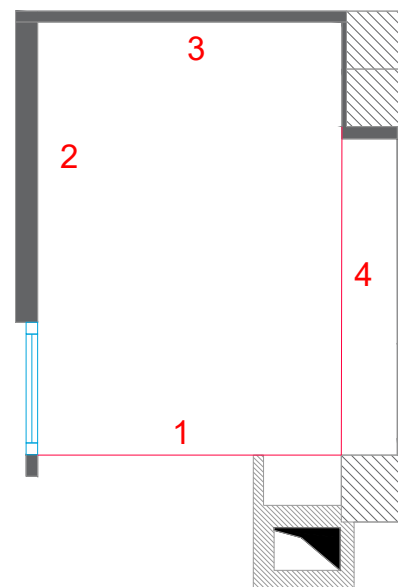
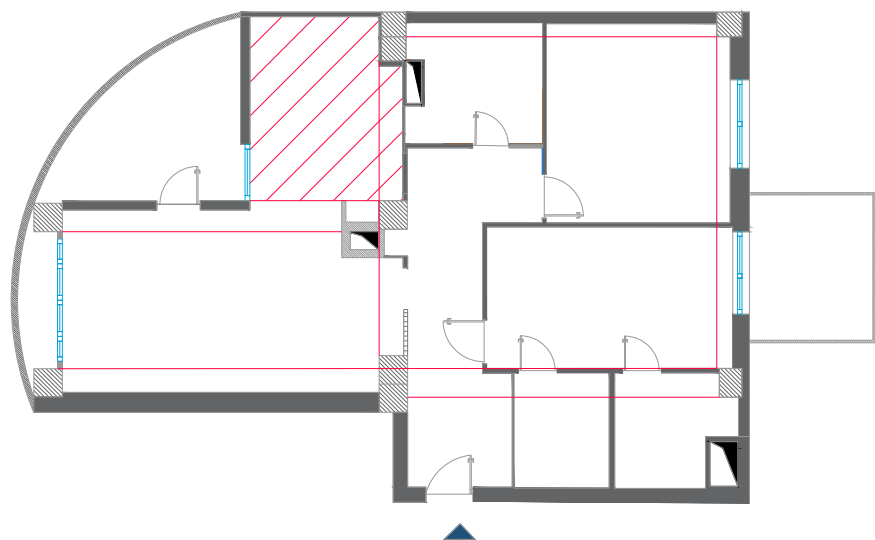
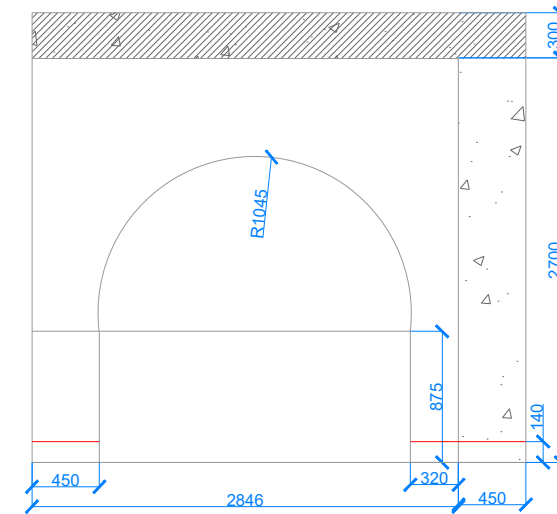

Founder	A. Danielyan
Teacher	D. Grigoryan
Student	S. Voskanyan

3 D Visualization

Our address  
16 Abovyan

page quantity	page number
39	13

« ARMAT Design School »

+(374) 55 70 73 33  
www.armatdesign.am

13

ARMAT  
DESIGN SCHOOL



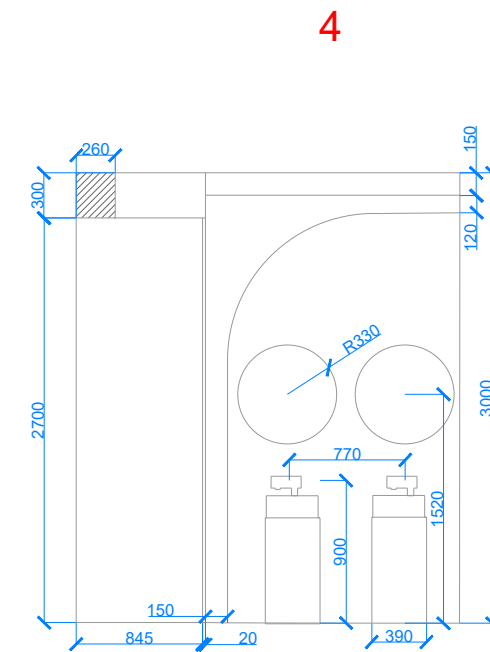
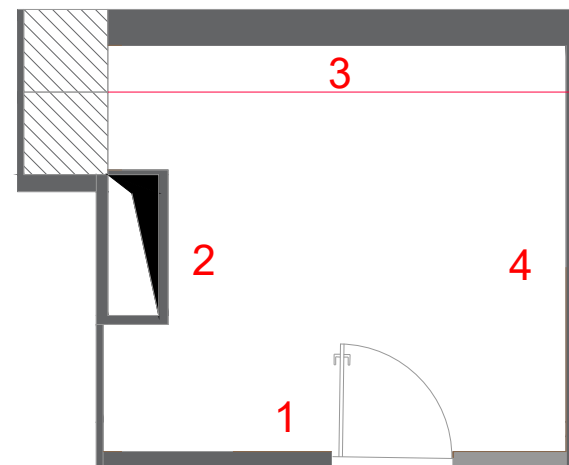
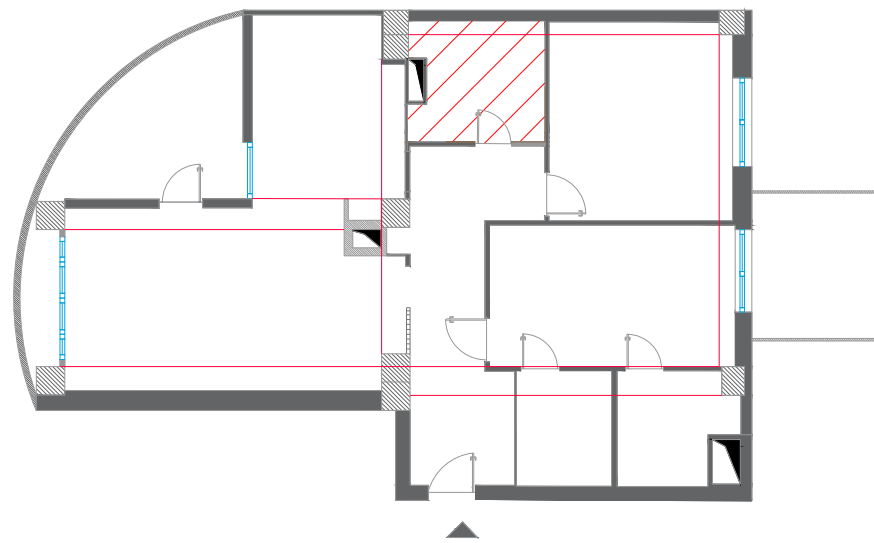
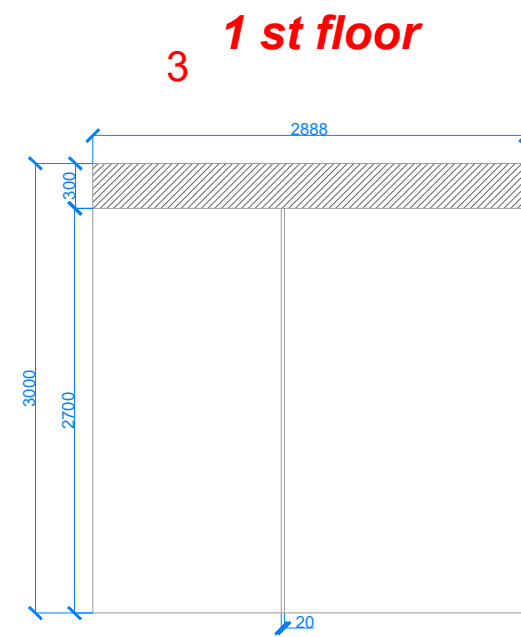
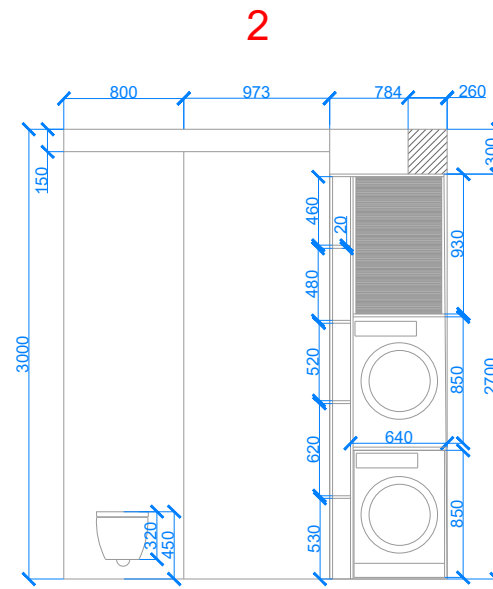
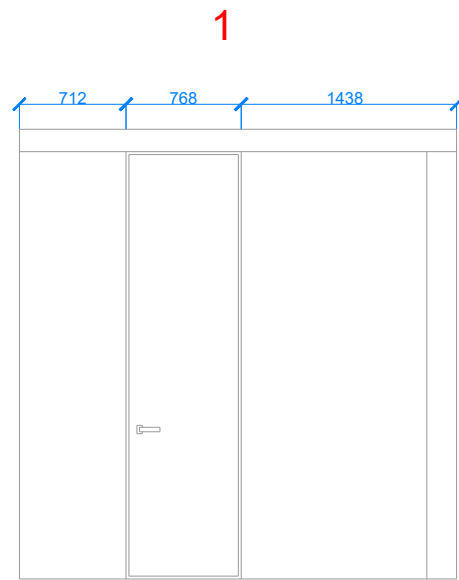

Founder	A. Danielyan
Teacher	D. Grigoryan
Student	S. Voskanyan

3 D Visualization

Our address	16 Abovyan
page quantity	39
page number	14
« ARMAT Design School »	

**Home office**

1

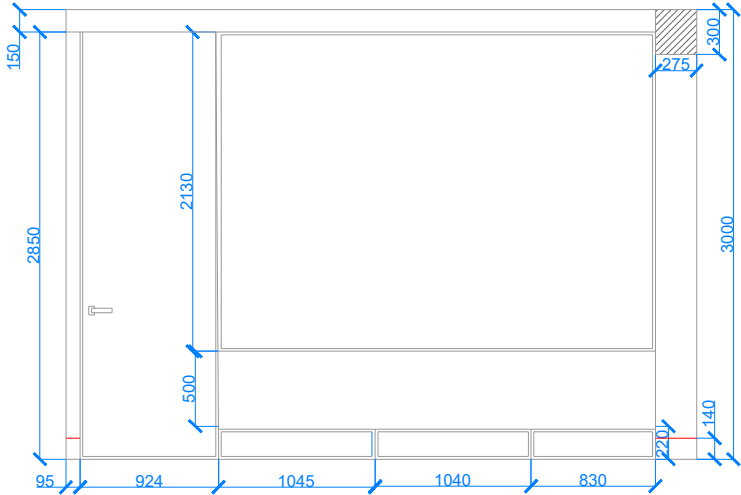

2

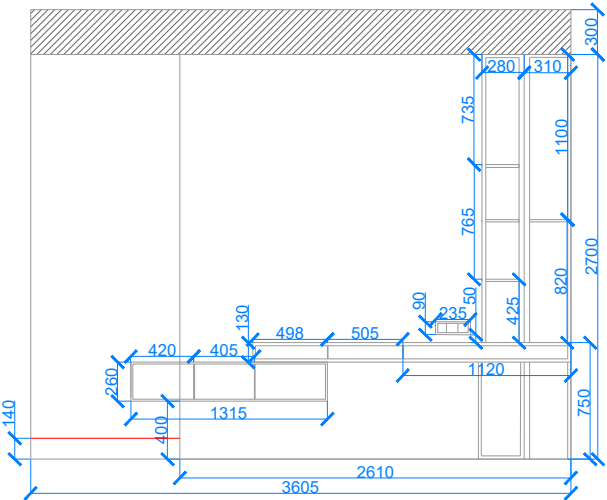

3

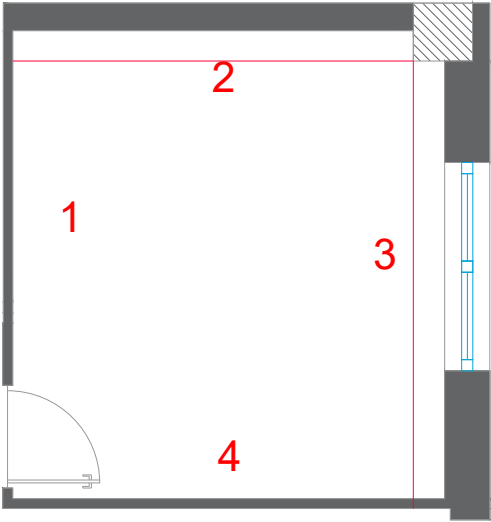
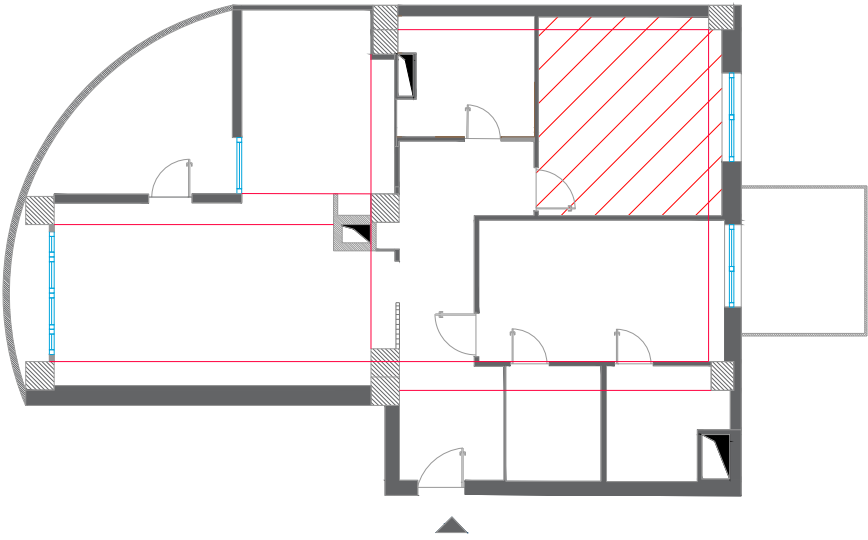
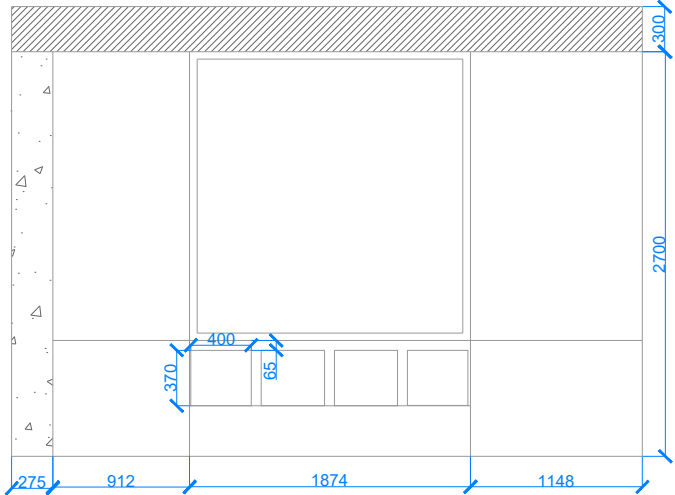

4

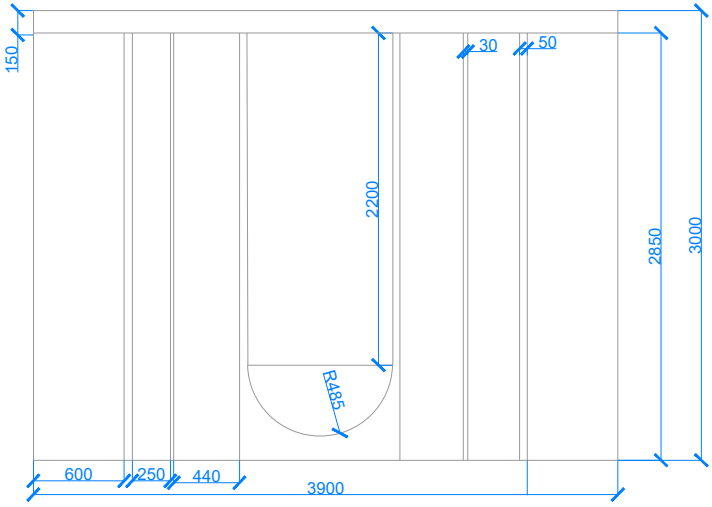

Founder	A. Danielyan
Teacher	D. Grigoryan
Student	S. Voskanyan

3 D Visualization

Our address  
16 Abovyan  
page quantity 39  
page number 15  
« ARMAT Design School »



1

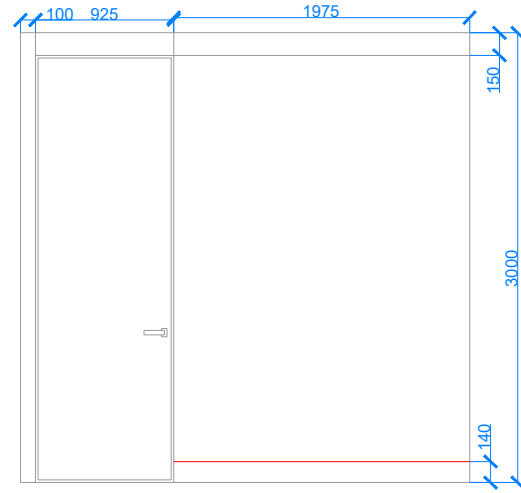

2

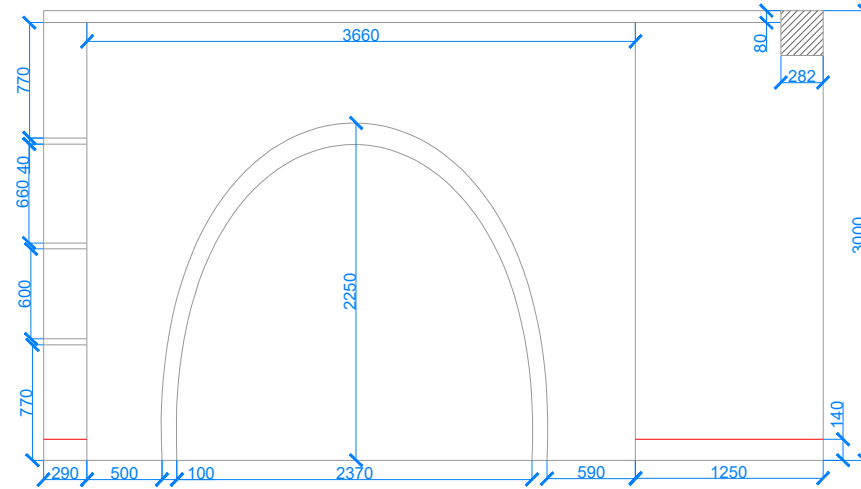

bedroom

3

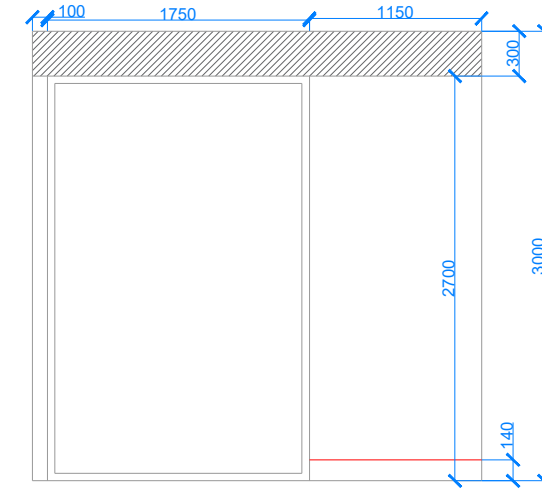

4

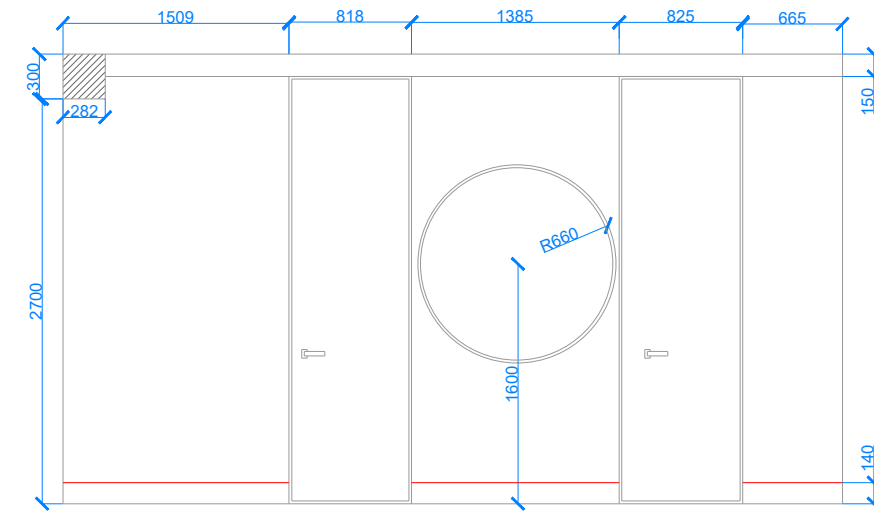
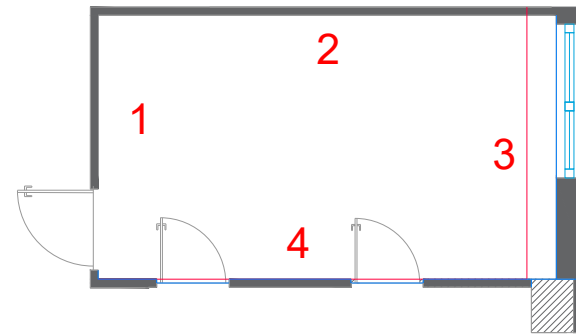
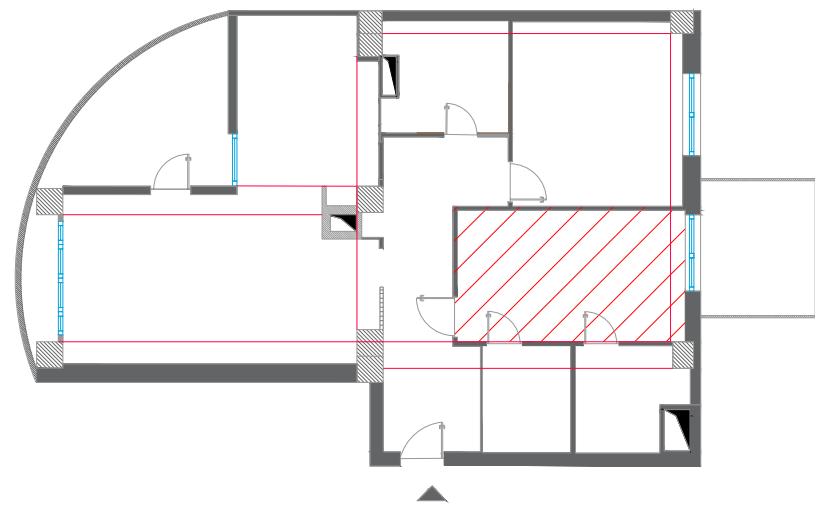

+(374) 55 70 73 33  
www.armatdesign.am

16

ARMAT  
DESIGN SCHOOL

Founder	A. Danielyan	3 D Visualization
Teacher	D. Grigoryan	
Student	S. Voskanyan	

Our address  
16 Abovyan  
page quantity 39  
page number 16  
« ARMAT Design School »





## 2-nd bathroom

1

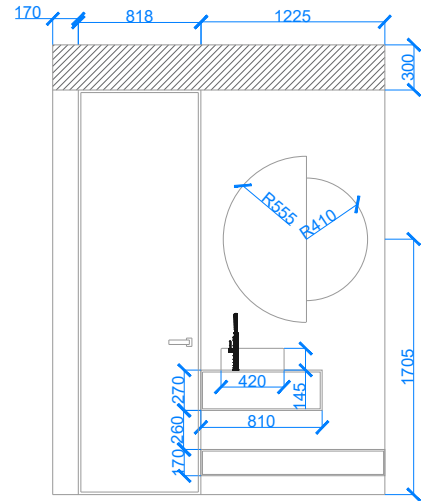

2

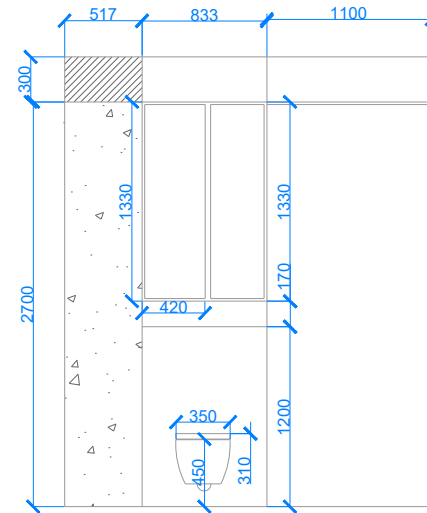

3

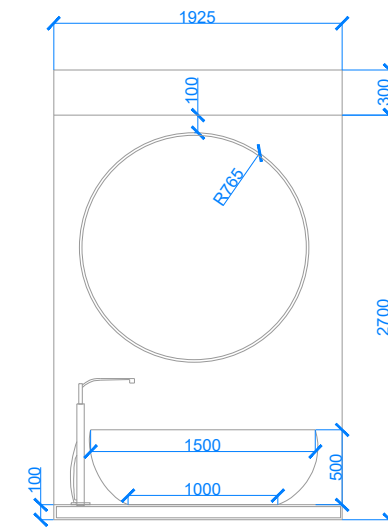

4

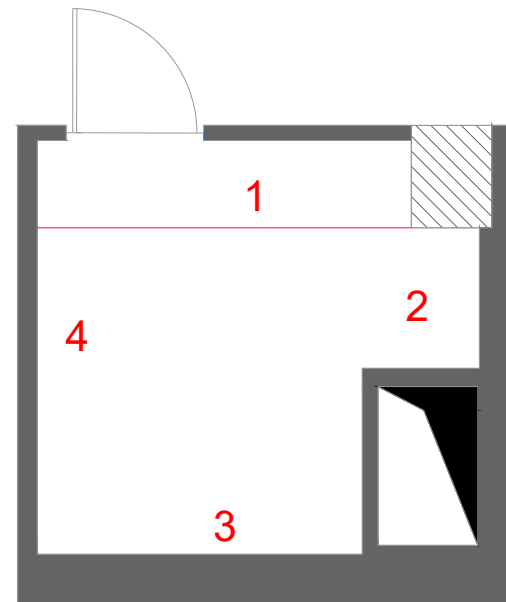
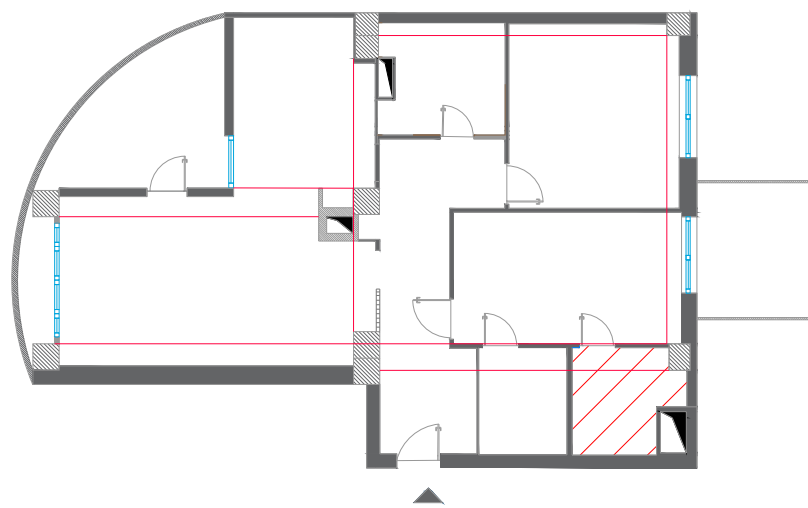
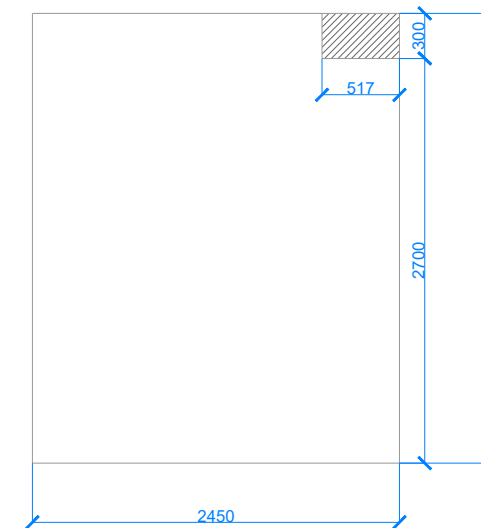

+(374) 55 70 73 33  
www.armatdesign.am

17

**ARMAT**  
DESIGN SCHOOL

Founder	A. Danielyan
Teacher	D. Grigoryan
Student	S. Voskanyan

3 D Visualization

Our address  
16 Abovyan

page quantity	page number
39	17

« ARMAT Design School »



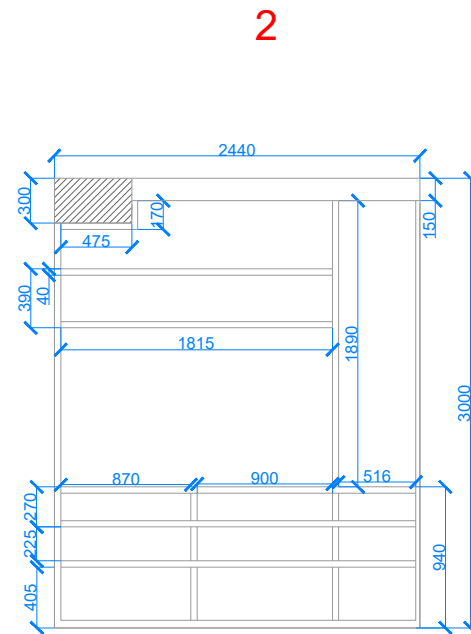
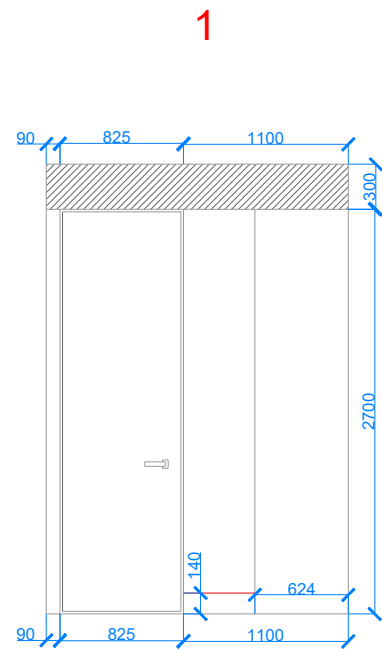

closet

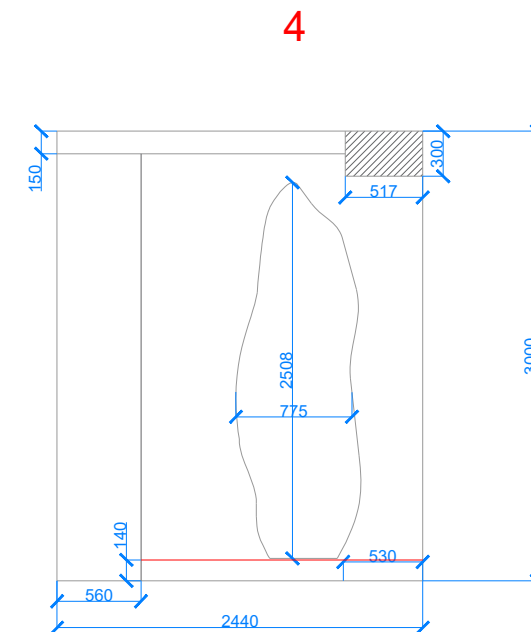
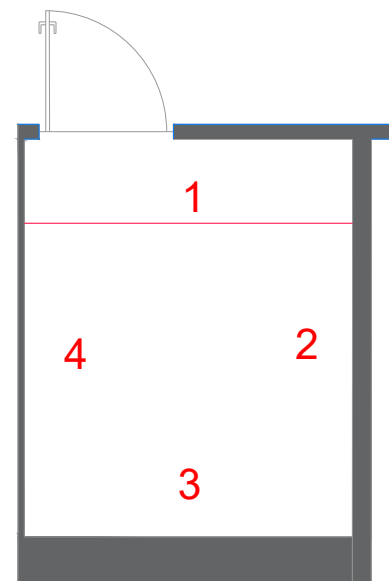
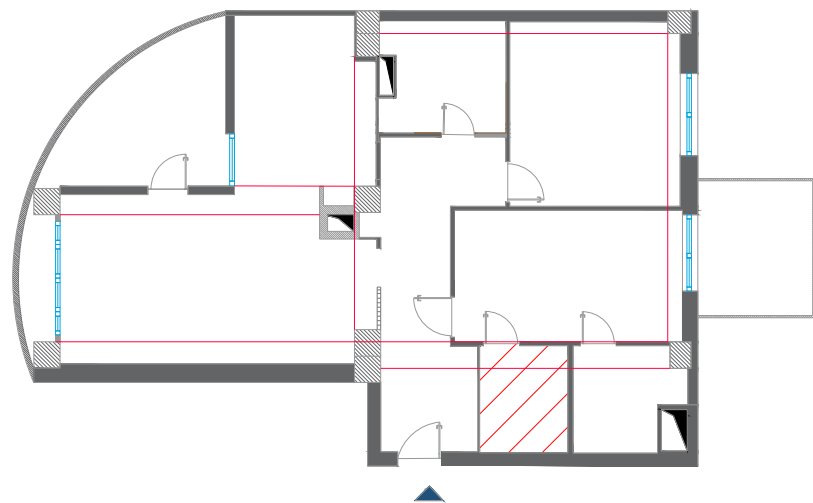
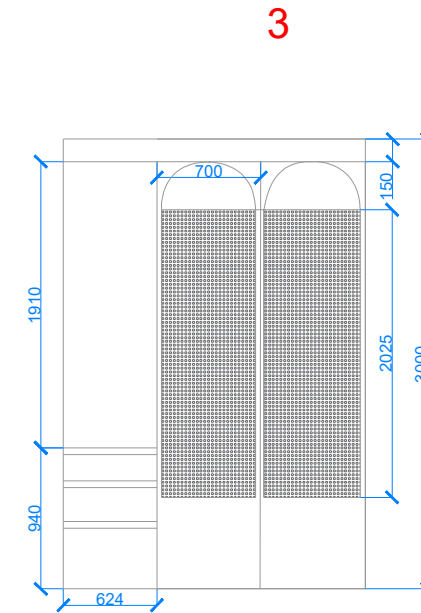

Founder	A. Danielyan
Teacher	D. Grigoryan
Student	S. Voskanyan

3 D Visualization

Our address  
16 Abovyan  
page quantity 39  
page number 18  
« ARMAT Design School »





Founder	A. Danielyan	3 D Visualization	Our address	16 Abovyan
Teacher	D. Grigoryan		page quantity	page number
Student	S.Voskanyan		39	35
			« ARMAT Design School »	







Founder	A. Danielyan
Teacher	D. Grigoryan
Student	S. Voskanyan

3 D Visualization

Our address  
16 Abovyan

page quantity	page number
39	20

« ARMAT Design School »





Founder	A. Danielyan
Teacher	D. Grigoryan
Student	S. Voskanyan

3 D Visualization

Our address 16 Abovyan	
page quantity	page number
39	21
« ARMAT Design School »	







Founder	A. Danielyan	3 D Visualization	Our address	
Teacher	D. Grigoryan		16 Abovyan	
Student	S.Voskanyan		page quantity	page number
			39	22
			« ARMAT Design School »	







Founder	A. Danielyan
Teacher	D. Grigoryan
Student	S. Voskanyan

3 D Visualization

Our address  
16 Abovyan

page quantity	page number
39	23

« ARMAT Design School »







Founder	A. Danielyan
Teacher	D. Grigoryan
Student	S. Voskanyan

3 D Visualization

	Our address 16 Abovyan
page quantity	page number
39	24
« ARMAT Design School »	







Founder	A. Danielyan
Teacher	D. Grigoryan
Student	S. Voskanyan

3 D Visualization

Our address	16 Abovyan
page quantity	39
page number	25
« ARMAT Design School »	







Founder	A. Danielyan	3 D Visualization	Our address	
Teacher	D. Grigoryan		16 Abovyan	
Student	S. Voskanyan		page quantity	page number
			39	26
			« ARMAT Design School »	







Founder	A. Danielyan
Teacher	D. Grigoryan
Student	S. Voskanyan

3 D Visualization

	Our address 16 Abovyan
page quantity	page number
39	27
« ARMAT Design School »	







Founder	A. Danielyan
Teacher	D. Grigoryan
Student	S.Voskanyan

3 D Visualization

Our address  
16 Abovyan

page quantity  
39

page number  
28

« ARMAT Design School »







Founder	A. Danielyan	3 D Visualization
Teacher	D. Grigoryan	
Student	S. Voskanyan	

Our address	16 Abovyan
page quantity	page number
39	29
« ARMAT Design School »	







Founder	A. Danielyan
Teacher	D. Grigoryan
Student	S. Voskanyan

3 D Visualization

Our address	16 Abovyan
page quantity	39
page number	30
« ARMAT Design School »	

+(374) 55 70 73 33  
www.armatdesign.am

30

**ARMAT**  
DESIGN SCHOOL







Founder	A. Danielyan
Teacher	D. Grigoryan
Student	S. Voskanyan

3 D Visualization

Our address	16 Abovyan
page quantity	39
page number	31
« ARMAT Design School »	

+(374) 55 70 73 33  
www.armatdesign.am







Founder	A. Danielyan
Teacher	D. Grigoryan
Student	S. Voskanyan

3 D Visualization

Our address  
16 Abovyan

page quantity	page number
39	32

« ARMAT Design School »







Founder	A. Danielyan	3 D Visualization
Teacher	D. Grigoryan	
Student	S. Voskanyan	

Our address  
16 Abovyan

page quantity	page number
39	33

« ARMAT Design School »

+(374) 55 70 73 33  
www.armatdesign.am

33

**ARMAT**  
DESIGN SCHOOL





Founder	A. Danielyan
Teacher	D. Grigoryan
Student	S. Voskanyan

3 D Visualization

	Our address 16 Abovyan
page quantity	page number
39	34
« ARMAT Design School »	





Founder	A. Danielyan	3 D Visualization
Teacher	D. Grigoryan	
Student	S. Voskanyan	

Our address  
16 Abovyan  
page quantity 39  
page number 35  
« ARMAT Design School »

